

**INDIAN ASSOCIATION OF PHYSICS TEACHERS
NATIONAL STANDARD EXAMINATION IN PHYSICS 2014 -15**

Date of Examination: 23rd November, 2014

Time: 0930 to 1130 Hrs

Q. Paper Code: P 152

Write the question paper code mentioned above on YOUR answer sheet (in the space provided), otherwise your answer sheet will NOT be assessed. Note that the same Q. P. Code appears on each page of the question paper.

Instructions to Candidates –

1. Use of mobile phones, smartphones, ipads during examination is **STRICTLY PROHIBITED**.
2. In addition to this question paper, you are given answer sheet along with Candidate's copy.
3. On the answer sheet, make all the entries carefully in the space provided **ONLY** in **BLOCK CAPITALS** as well as by properly darkening the appropriate bubbles. **Incomplete/ incorrect/carelessly filled information may disqualify your candidature.**
4. On the answer sheet, use only **BLUE** or **BLACK BALL POINT PEN** for making entries and filling the bubbles.
5. Question paper has two parts. In Part A1(Q. Nos 1 to 60) each question has four alternatives, out of which **only one** is correct. Choose the correct alternative and fill the appropriate bubble, as shown.

Q. No. 22 a b c d

In Part A2 (Q. Nos. 61 to 70) each question has four alternatives out of which **any number of alternatives** (1, 2, 3 or 4) may be correct. You have to choose ALL correct alternatives and fill the appropriate bubbles, as shown.

Q. No. 64 a b c d

6. For **Part A1**, each correct answer gets 3 marks. A wrong one gets a penalty of 1 mark. **Part A2** full marks are 6 for each question, you get them when **ALL** correct answers are marked.
7. Any rough work should be done only in the space provided.
8. Use of **non-programmable** calculator is allowed.
9. No candidate should leave the examination hall before the completion of the examination.
10. After submitting your answer paper, take away the Candidate's copy for your reference.

Please DO NOT make any mark other than filling the appropriate bubbles properly in the space provided on the answer sheet.

Answer sheets are evaluated using machine, hence CHANGE OF ENTRY IS NOT ALLOWED.

Scratching or overwriting may result in a wrong score.

DO NOT WRITE ON THE BACK SIDE OF THE ANSWER SHEET.

Instructions to Candidates (continued)–

Read the following instructions after submitting the answer sheet.

11. Comments regarding this question paper, if any, may be sent by email only to iaptpune@gmail.com till 25th November, 2014.
12. The answers/solutions to this question paper will be available on our website – www.iapt.org.in by 3rd December, 2014.
13. **CERTIFICATES and AWARDS –**
Following certificates are awarded by the IAPT to students successful in NSEs
 - (i) Certificates to “Centre Top 10%” students
 - (ii) Merit Certificates to “Statewise Top 1%” students
 - (iii) Merit Certificates and a book prize to “National Top 1%” students
14. Result sheets and the “Centre Top 10%” certificates will be dispatched to the Prof-in-charge of the centre by January, 2015.
15. List of students (with centre number and roll number only) having score above MAS will be displayed on our website (www.iapt.org.in) by 22nd December, 2014. See the **Eligibility Clause** in the Student’s brochure on our website.
16. Students eligible for the INO Examination on the basis of selection criteria mentioned in Student’s brochure will be informed accordingly.
17. Gold medals will be awarded to TOP 35 students in the entire process.

**INDIAN ASSOCIATION OF PHYSICS TEACHERS
NATIONAL STANDARD EXAMINATION IN PHYSICS 2014-15**

Total Time : 120 minutes (A-1 and A-2)

A – 1

ONLY ONE OUT OF FOUR OPTIONS IS CORRECT.

N. B. – Physical constants are given at the end.

1. If the threshold of hearing is assumed to be the reference (0 dB), then the threshold of pain is taken to be 120 dB. Let the corresponding sound intensities be I_0 and I respectively. Then, $\frac{I_0}{I}$ is
(a) 120 (b) 10^{12} (c) 10^{-12} (d) $10^{1.2}$

2. If E denotes the intensity of electric field, the dimensions of a quantity $\epsilon_0 \frac{dE}{dt}$ are those of
(a) current (b) current density (c) electric potential (d) electric flux

3. Two stars of masses m_1 and m_2 distance r apart revolve about their centre of mass. The period of revolution is
(a) $2\pi \sqrt{\frac{r^3}{2G(m_1+m_2)}}$ (b) $2\pi \sqrt{\frac{r^3(m_1+m_2)}{2G(m_1m_2)}}$ (c) $2\pi \sqrt{\frac{2r^3}{G(m_1+m_2)}}$ (d) $2\pi \sqrt{\frac{r^3}{G(m_1+m_2)}}$

4. Let a body be placed at a point on the earth's surface at a latitude λ where the radius of the earth is R . Then, the body experiences an effective acceleration
(a) $g - R\omega^2 \cos \lambda$ (b) $g + R\omega^2 \sin \lambda$ (c) $g - R\omega^2 \cos^2 \lambda$ (d) $g - \frac{R\omega^2}{\cos^2 \lambda}$

5. A particle moves in a plane with a constant speed along a path $y = 2x^2 + 3x - 4$. When the particle is at $(0, -4)$ the direction along which it is moving is inclined to the X axis at an angle
(a) 63° (b) 72° (c) 27° (d) 0°

6. Two particles A and B are moving in XY plane. Particle A moves along a line with equation $y = x$ while B moves along X axis such that their X coordinates are always equal. If B moves with a uniform speed 3 m/s, the speed of A is
(a) 3 m/s (b) $\frac{1}{3}$ m/s (c) $3\sqrt{2}$ m/s (d) $\frac{3}{\sqrt{2}}$ m/s

Q. P. Code - P 152

7. A large cylindrical vessel contains water to a height of 10 m. It is found that the thrust acting on the curved surface is equal to that at the bottom. If atmospheric pressure can support a water column of 10 m, the radius of the vessel is
(a) 10 m (b) 15m (c) 5 m (d) 25 m
8. A thin annular metal disc of inner and outer radii R_1 and R_2 respectively, is freely suspended from a point on its outer circumference. The length of the corresponding equivalent simple pendulum is
(a) $\frac{R_1^2 + R_2^2}{2R_2}$ (b) $\frac{R_1^2 + 3R_2^2}{2R_2}$ (c) $\frac{3R_1^2 + R_2^2}{R_2}$ (d) $\frac{R_1^2 + 3R_2^2}{R_2}$
9. Two identical thin metal strips, one of aluminum and the other of iron are riveted together to form a bimetallic strip. The temperature is raised by 50°C . If the central planes of the two strips are separated by 2 mm and the coefficients of thermal expansion for aluminum and iron are respectively $30 \times 10^{-6} / ^\circ\text{C}$ and $10 \times 10^{-6} / ^\circ\text{C}$, the average radius of curvature of the bimetallic strip is about
(a) 50 cm (b) 100 cm (c) 150 cm (d) 200 cm
10. Standing waves are generated on a string loaded with a cylindrical body. If the cylinder is immersed in water, the length of the loops changes by a factor of 2.2. The specific gravity of the material of the cylinder is
(a) 1.11 (b) 2.15 (c) 2.50 (d) 1.26
11. A curved road with radius of curvature 200 m is banked with an angle of banking equal to $\tan^{-1}(0.2)$. Now, if the traffic is at double the speed for which the road is designed, the minimum value of the frictional coefficient needed is ($g = 10 \text{ m/s}^2$)
(a) 0.52 (b) 0.35 (c) 0.94 (d) 0.80
12. A plastic pipe filled with iron wires forms a soft iron core. Two identical coils that can just slide over the pipe are placed on this soft iron core. Initially the pipe is kept horizontal and a current is passed through the coils connected in series. The fields are in opposition and the coils remain stationary with a separation of 5 cm. The system is now made vertical and the separation between the coils reduces to 4 cm. Then the coefficient of friction between the coils and the pipe is
(a) 0.41 (b) 0.02 (c) 0.5 (d) 0.3
13. A long straight wire carries a charge with linear density λ . A particle of mass m and a charge q is released at a distance r from the wire. The speed of the particle as it crosses a point distance $2r$ is
(a) $\sqrt{\frac{q\lambda \ln r}{\pi m \epsilon_0}}$ (b) $\sqrt{\frac{q\lambda \ln 2}{\pi m \epsilon_0}}$ (c) $\sqrt{\frac{q\lambda \ln 2}{2\pi m \epsilon_0}}$ (d) $\sqrt{\frac{2q\lambda \ln r}{\pi m \epsilon_0}}$

Q. P. Code - P 152

14. A uniform meter scale is supported from its 20 cm mark. A body suspended from 10 cm mark keeps the scale horizontal. However, the scale gets unbalanced if the body is completely immersed in water. To regain the balance the body is shifted to the 8 cm mark. Therefore, the specific gravity of the material of the body is
(a) 5 (b) 6 (c) 7 (d) 4
15. Temperature of 100 g of water in a thermoflask remains fixed for a pretty long time at 50°C. An equal mass of sand at 20°C is poured in the flask and shaken for some time so that the temperature of the mixture is 40°C. Now the experiment is repeated with 100 g of a liquid at 50°C and an equal amount of sand at 20°C when the temperature of the mixture is found to be 30°C. The specific heat of the liquid (in $\text{kJ kg}^{-1}\text{K}^{-1}$) is
(a) 1.05 (b) 2.01 (c) 1.55 (d) 1.95
16. Let v_{avg} , v_p and v_{rms} be respectively the average, the most probable and the root mean square speeds of gas molecules according to Maxwell's distribution. Then,
(a) $v_{\text{avg}} < v_p < v_{\text{rms}}$ (b) $v_p < v_{\text{rms}} < v_{\text{avg}}$ (c) $v_{\text{rms}} < v_p < v_{\text{avg}}$ (d) $v_p < v_{\text{avg}} < v_{\text{rms}}$
17. A coal-based thermal power plant producing electricity operates between the temperatures 27°C and 227°C. The plant works at 80% of its maximum theoretical efficiency. Complete burning of 1 kg of coal yields 36000 kJ of heat. A house needs 10 units of electricity each day. Coal used for supplying the amount of energy for the house in one year is
(a) 1141 kg (b) 580 kg (c) 605 kg (d) 765 kg
18. A copper-constantan thermocouple has thermoelectric power $40 \mu\text{V}/^\circ\text{C}$. One junction is at 0°C while the other is at 50°C. The thermocouple is connected to a 30-0-30 galvanometer to produce a full scale deflection. If a 100 ohm resistance is connected in series with the galvanometer, the galvanometer gives a deflection of 10 divisions. The figure of merit of the galvanometer is
(a) $1.3 \mu\text{A}/\text{div}$ (b) $2.0 \mu\text{A}/\text{div}$ (c) $2.3 \mu\text{A}/\text{div}$ (d) $4.0 \mu\text{A}/\text{div}$
19. A fresh dry cell of 1.5 volt and two resistors of $10 \text{ k}\Omega$ each are connected in series. An analog voltmeter measures a voltage of 0.5 volt across each of the resistors. A $1000 \mu\text{F}$ capacitor is fully charged using the same source. the same voltmeter is now used to measure the voltage across it. The initial value of the current and the time in which the voltmeter reading falls to 0.5 volt are respectively
(a) $60 \mu\text{A}$, 11 s (b) $120 \mu\text{A}$, 15 s (c) $150 \mu\text{A}$, 15 s (d) $150 \mu\text{A}$, 11 s
20. A charge of $+2 \mu\text{C}$ is situated off-centre of a hollow spherical metallic shell. Then,
(a) $-2 \mu\text{C}$ charge gets uniformly distributed on the inner surface of the shell.
(b) $+2 \mu\text{C}$ charge gets non-uniformly distributed on the outer surface of the shell.
(c) $-2 \mu\text{C}$ charge gets non-uniformly distributed on the inner surface of the shell.
(d) no charge appears on the outer surface of the shell.

Q. P. Code - P 152

21. Two simple pendulums with heavy bobs – one using iron wire and the other aluminium wire are excited simultaneously. It is found that when the first pendulum completes 1000 oscillations the other completes 1001. When the temperature is raised by $t^{\circ}\text{C}$, it is found that the two pendulums now oscillate together. If the coefficients of thermal expansion of iron and aluminium are $10 \times 10^{-6}/^{\circ}\text{C}$ and $30 \times 10^{-6}/^{\circ}\text{C}$, the value of t is
(a) 77.2°C (b) 123.2°C (c) 100.1°C (d) 105.2°C
22. Consider a body moving through air at a speed greater than that of sound. Out of the following terms that one which is NOT connected with this event is
(a) sonic boom (b) ultrasonic (c) Mach number (d) conical wavefront
23. A short bar magnet is placed along N-S direction with N pole pointing north. The neutral points are located 20 cm away from the bar magnet. If B_H is the horizontal component of earth's magnetic field, then the magnetic field due to the bar magnet at a distance of 40 cm along its axis is
(a) $\frac{B_H}{2}$ (b) $\frac{B_H}{4}$ (c) $\frac{B_H}{8}$ (d) $\frac{B_H}{16}$
24. A plane mirror coincides with a plane having equation $x = 3$. A particle is moving along a line with direction ratios 3,4,5. If speed of the particle is $\sqrt{2}$, the velocity of its image is
(a) $\frac{3}{5}\hat{i} + \frac{4}{5}\hat{j} + \frac{1}{5}\hat{k}$ (b) $-\frac{3}{5}\hat{i} - \frac{4}{5}\hat{j} - \hat{k}$ (c) $\frac{3}{5}\hat{i} + \frac{4}{5}\hat{j} - \frac{1}{5}\hat{k}$ (d) $-\frac{3}{5}\hat{i} + \frac{4}{5}\hat{j} + \hat{k}$
25. An unpolarized light is travelling along Z axis through three polarizing sheets. The polarizing directions of the first and the third sheet are respectively parallel to X axis and Y axis whereas that of the second one is at 60° to the Y axis. Then, the fraction of the initial light intensity that emerges from the system is about
(a) zero (b) 0.093 (c) 0.031 (d) 0.28
26. One face of a glass ($\mu = 1.50$) lens is coated with a thin film of magnesium fluoride MgF_2 ($\mu = 1.38$) to reduce reflection from the lens surface. Assuming the incident light to be perpendicular to the lens surface, the least coating thickness that eliminates the reflection at the centre of the visible spectrum ($\lambda = 550 \text{ nm}$) is about
(a) $0.05 \mu\text{m}$ (b) $0.10 \mu\text{m}$ (c) $1.38 \mu\text{m}$ (d) $2.80 \mu\text{m}$
27. Consider the analogy between an oscillating spring-body system and an oscillating LCR circuit. Then, the correspondence between the two systems that is NOT correct is
(a) charge q corresponds to displacement x of the body.
(b) inductance L corresponds to mass m of the body.
(c) capacitance C corresponds to spring constant k .
(d) magnetic energy corresponds to kinetic energy of the body.

Q. P. Code - P 152

28. A 50 Hz ac source is connected to a capacitor C in series with a resistance $1\text{ k}\Omega$. The rms voltages measured across them are 5 volt and 2 volt respectively. Assume the capacitor to be ideal. The peak value of the source voltage and the capacitance are respectively
 (a) 7 V, $1.27\ \mu\text{F}$ (b) 5.3 V, $2.3\ \mu\text{F}$ (c) 7.62 V, $1.27\ \mu\text{F}$ (d) 3 V, $2.3\ \mu\text{F}$

29. Refer to the circuit given below. Initially the switch S is in position 1 for 1.5 s. Then the switch is changed to position 2. After a time t (measured from the change-over of the switch) the voltage across $5\text{ k}\Omega$ resistance is found to be about 1.226 volt. Then, t is

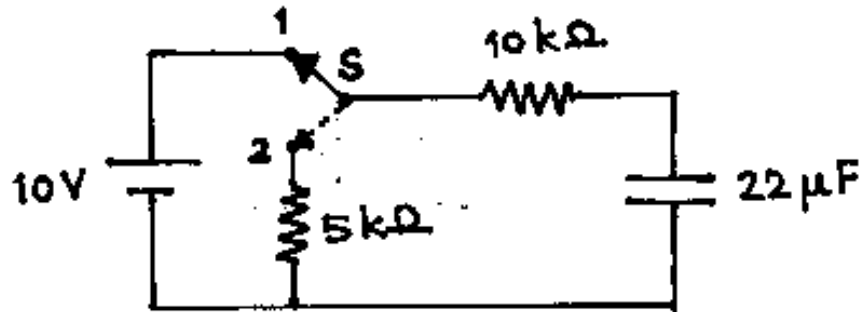

- (a) 330 ms (b) 500 ms (c) 33 ms (d) data insufficient

30. A long straight wire of radius R carries a uniformly distributed current i . The variation of magnetic field B from the axis of the wire is correctly represented by the graph

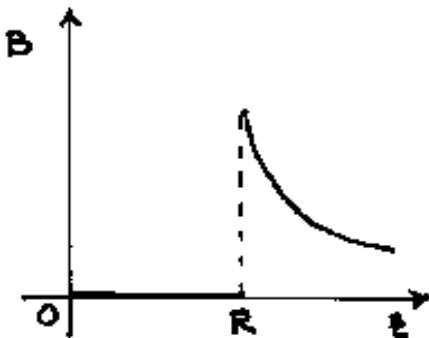

(a) (b)

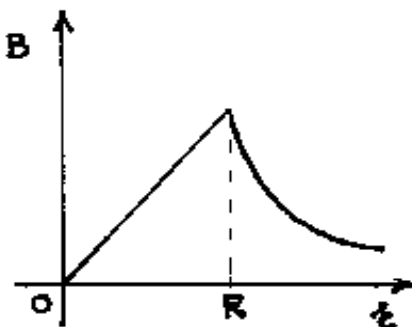
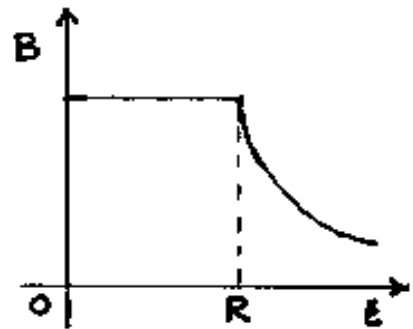

(c)

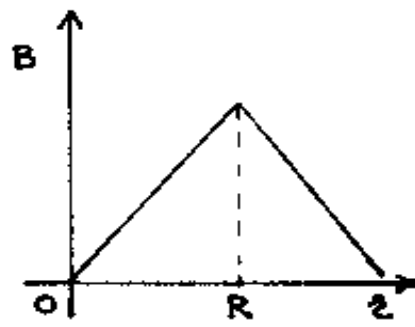

(d)

Q. P. Code - P 152

31. Two copper coils A and B are wound over a plastic pipe. Coil A is connected to a sinusoidal voltage source of frequency 50 Hz so that a current of 100 mA passes through it. The voltage across coil B is 5 volt. Now if coil B is short circuited, there is a change of current of 2 mA in coil A. Then, the mutual inductance between the two coils and the percentage change in the impedance of coil A are respectively
 (a) 160 mH, 2% (b) 16 mH, 0% (c) 1.6 mH, 2% (d) 0.16 mH, 0%

32. A coil is wound on an iron rod and connected to an ac source as shown in the figure. Two more coils AB and CD are also wound on the same rod. If ends B and C are joined, a filament bulb connected between ends A and D glows well. However, if B and D are joined and the bulb is connected between A and C, it glows feebly. This shows that

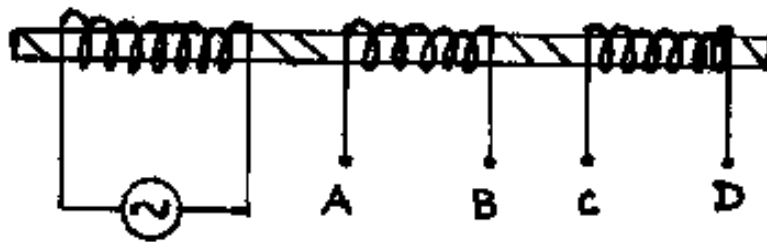

- (a) coils AB and CD are in series in the first case while they are in parallel in the second case.
 (b) in the second case the two coils are in phase addition and they have unequal number of turns.
 (c) in the second case the two coils are in phase opposition and they have equal number of turns.
 (d) in the second case the two coils are in phase opposition and they have unequal number of turns.
33. The age of an organic material is usually determined by measuring its ^{14}C content (carbon dating). The ratio of the number of stable isotope of ^{14}C atoms present to the number of radioactive ^{14}C atoms in a certain material is found to be 3:1. If the half life of ^{14}C atoms is 5730 years, the age of the material under investigation is
 (a) 7944 years (b) 17190 years (c) 11460 years (d) 13972 years

34. The arrangement of NAND gates shown below effectively works as

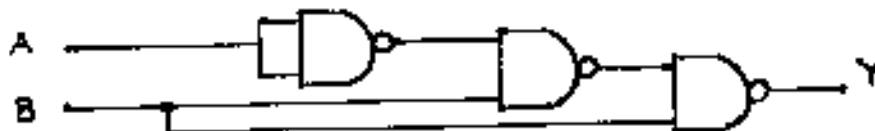

- (a) AND gate (b) OR gate (c) NAND gate (d) NOR gate

Q. P. Code - P 152

35. A uniform thin rod of length $(4a + 2\pi a)$ and of mass $(4m + 2\pi m)$ is bent and fabricated to form a square surrounded by semicircles as shown in the figure. The moment of inertia of this frame about an axis passing through its centre and perpendicular to its plane is

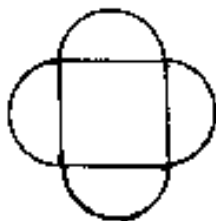

- (a) $\frac{(4+2\pi)}{3}ma^2$ (b) $\frac{(4+\pi)}{2}ma^2$ (c) $\frac{(4+3\pi)}{3}ma^2$ (d) $\frac{(3+\pi)}{2}ma^2$

36. A ball is dropped onto a horizontal surface from a height of 36 cm. After bouncing several times it comes to rest covering a total distance of 100 cm measured in a vertical direction. The percentage loss in its kinetic energy after its first impact is
 (a) 36 (b) 64 (c) 53 (d) 96

37. A simple pendulum has a small disc shaped magnet as the bob whose magnetic moment is along vertical. Just beneath the bob a current carrying coil is placed on a horizontal table. The coil produces a uniform magnetic field. The dependence of the change in time period $|\Delta T|$ on current i can be graphically shown as

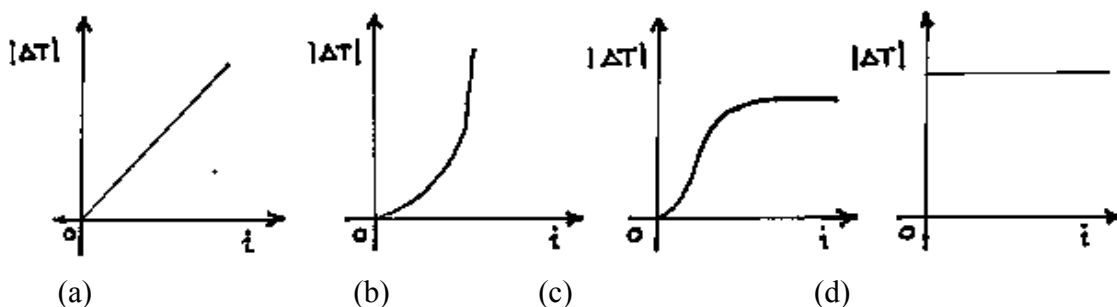

38. Two coupled simple pendulums have nearly the same period. One of them is excited while the other is at rest. Now energy keeps on transferring from one pendulum to the other alternately. This periodic transfer of energy continues almost indefinitely with a time period of 10 s. Then the difference of frequencies between the two pendulums is
 (a) zero Hz (b) 0.1 Hz (c) 0.01 Hz (d) infinite

Q. P. Code - P 152

39. A beam of 28 keV electrons strikes a target generating X rays. The minimum wave length λ_{\min} (called cutoff wavelength) of the X rays generated is
 (a) 4.4 nm (b) 44 nm (c) 0.044 nm (d) 0.44 nm

Group of Q. Nos. 40 to 47 are based on the following paragraph.

A potentiometer is made using a resistance wire about 5 m long and having a resistance of $8 \Omega/\text{m}$. The diagram shows the arrangement on a wooden board. The wire is turned round brass screws (P) used as pegs giving 5 parallel segments 1.0 m each. The wire remains taut under moderate tension. It is held in place by strips 3 mm thick marked as S and S'. The experimental circuit shows the labeled electrical components. L is Leclanche cell (emf $e_1 = 1.40$ volt) and D is Daniel cell (emf $e_2 = 1.08$ volt). *Note that answers obtained in any earlier question/s may be needed in further questions and such answers should be used wherever needed.*

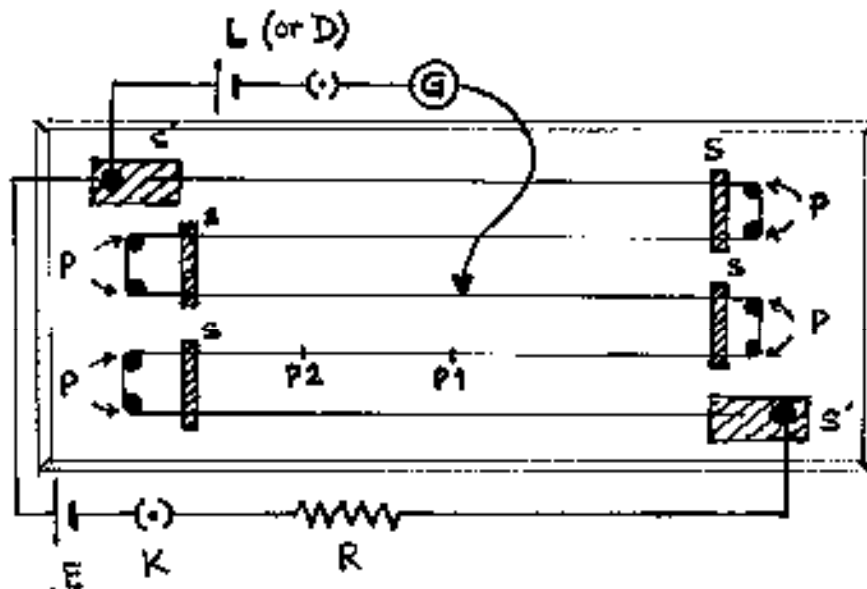

40. It is required to decide the ratio (e_1 / e_2) by sum and difference method ALSO. Four cells with different values of emfs E are available. One must use a cell with emf E equal to
 (a) 1.40 volt (b) 2.0 volt (c) 4.50 volt (d) 1.08 volt
41. The best material for strips marked S and S' is
 (a) plastic (b) aluminium (c) cast iron (d) plated brass
42. Assuming that due to stretching of wire while preparing the potentiometer, its resistance has increased by 2% and a potential gradient of 0.6 mV/mm is needed, then R must be
 (a) 13.5 ohm (b) 40.8 ohm (c) 20.4 ohm (d) 135 ohm

Q. P. Code - P 152

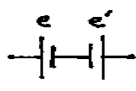
43. It is claimed that the strips S and S' serve two purposes – (I) to decide the end points of the wire, and (II) to keep the wire in its place. Then,
 (a) both (I) and (II) are important.
 (b) (I) is more important than (II).
 (c) (II) is more important than (I).
 (d) both are unimportant.
44. The length of wire between the adjoining pegs carries current
 (a) equal to that in the potentiometer wire.
 (b) equal to half the current in the potentiometer wire.
 (c) nearly zero.
 (d) equal to zero.
45. Two new and different cells having emf's v_1 and v_2 have their balance points P_1 and P_2 respectively. Then,
 (a) $v_1 > v_2$ (b) $v_1 < v_2$ (c) $v_1 = v_2$ (d) information is not sufficient.
46. The 'emf under test' contains an arrangement as  connected in the circuit. It is observed that wherever the jockey is touched to wire the galvanometer shows full scale deflection only on one side. The possible causes (considered one at a time) are (I) e is D and e' is L, (II) e is L and e' is D, (III) key K is not inserted, (IV) value of R is much larger than that set as per Q. No. 42, (V) value of R is very small. The possible causes are
 (a) (I), (II) and (III) (b) (II), (III) and (IV)
 (c) (I), (III) and (IV) (d) (II), (III) and (V)
47. If the jockey is touched at a point on the wire 1.0 cm away from the balance point, then the galvanometer ($G = 1 \text{ k}\Omega$) will show a current equal to
 (a) $2 \mu\text{A}$ (b) $4 \mu\text{A}$ (c) $6 \mu\text{A}$ (d) $8 \mu\text{A}$

Group of Q. Nos. 48 to 55 are based on the following paragraph.

A large number of pendulums with identical bobs (mass m) but varying lengths are suspended from a thick thread. Another pendulum of a heavier bob (mass M) is also suspended from the same thread as shown.

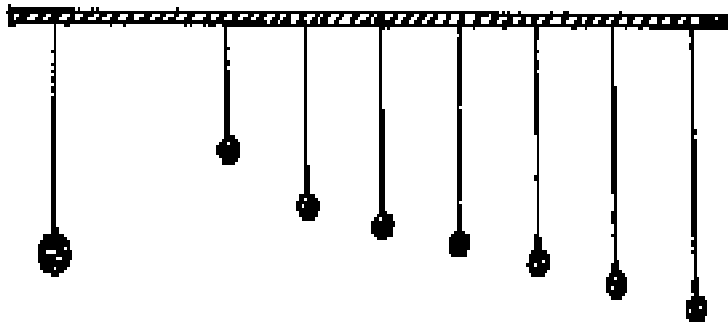

Q. P. Code - P 152

This pendulum with the heavier bob is used as a 'driver' to drive the other pendulums called as 'driven' pendulums. Assume that the amplitude of the driver is maintained constant (by some suitable mechanism). Let the frequency of the driver be f_0 .

48. The time periods – hence the frequencies (f) and the amplitudes (A) of the driven pendulums in steady state are measured. The variation of A with f is correctly shown by the graph

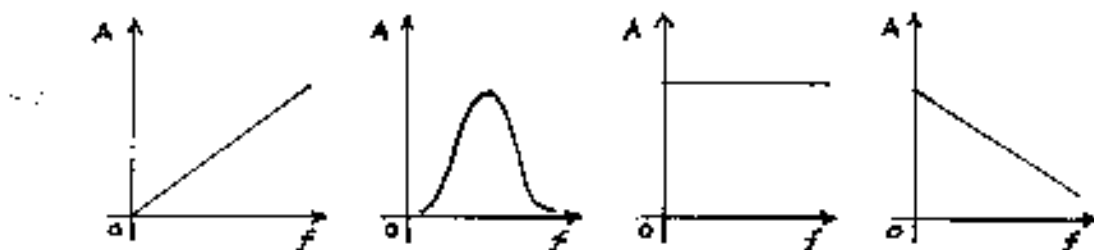

- (a)(b) (c) (d)

49. It is observed that

- (a) all the pendulums except one are at rest.
- (b) all the pendulums oscillate in phase with the 'driver'.
- (c) one of the pendulums oscillates with maximum amplitude.
- (d) the pendulum with maximum amplitude oscillates in phase with the 'driver'.

50. The frequency of the pendulum having maximum amplitude is

- (a) $f_0 / 2$
- (b) f_0
- (c) $2 f_0$
- (d) not related to f_0

51. The pendulum in Q. No. 50 above is set into oscillation with an initial amplitude of 10.0 cm. Soon this pendulum comes to rest momentarily and the driver is seen to oscillate with an amplitude of 8.16 cm. Then, mass M equals

- (a) $1.5 m$
- (b) $2 m$
- (c) $2.5 m$
- (d) $3 m$

Now only one of the driven pendulums is oscillated. The driver and all other driven pendulums are clamped.

52. A simple pendulum of length L has a period T . If length is changed by ΔL , the change in period ΔT is proportional to

- (a) T
- (b) T^2
- (c) $\frac{1}{T}$
- (d) $\frac{1}{\sqrt{T}}$

Q. P. Code - P 152

53. The variation of amplitude A with respect to time t is shown as

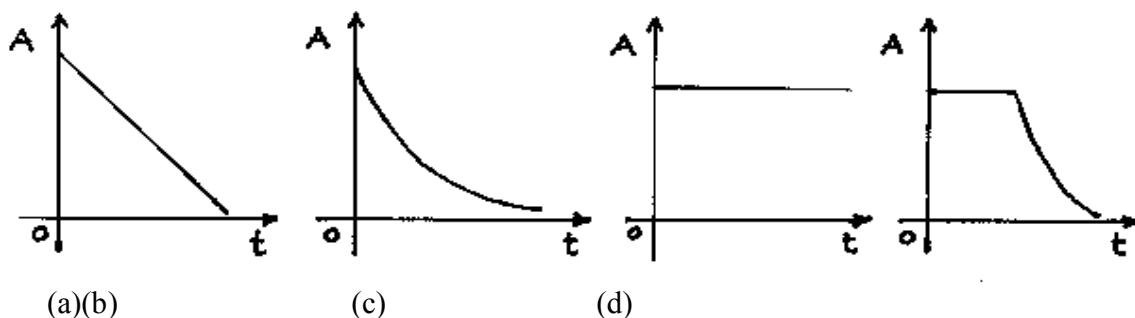

54. Which of the following will give a straight line graph?

- (a) $\log A$ against t (b) $\log A$ against $1/t$ (c) A against t^2 (d) A^2 against t

55. If v is the velocity of the bob the force that is responsible for decrease of amplitude is proportional to

- (a) v^2 (b) v (c) $\frac{1}{v}$ (d) $\frac{1}{v^2}$

Q. Nos. 56 to 60 are to be solved as group questions.

Note that answers obtained in any earlier question/s may be needed in further questions and such answers should be used wherever needed.

56. An object is placed 30 cm away from a symmetric convex lens and an image two thirds of the size of the object is produced. The object is moved by a distance of 20 cm so as to get a magnified image. Now we get

- (a) a real image of magnification $\frac{17}{6}$.
(b) a virtual image of magnification 5.
(c) a real image at a distance of 40 cm.
(d) a virtual image at a distance of 60 cm.

57. A symmetric concave lens of focal length 24 cm is now placed in contact with the convex lens and the object is brought back to its original position. The image formed will be

- (a) a real one with a magnification 4.
(b) a real one at a distance of 40 cm.
(c) a virtual one at a distance of 120 cm.
(d) a virtual one with a magnification 2.5.

Q. P. Code - P 152

58. The concave lens is moved away from the object through a distance of 10 cm. We get an image that is
- (a) virtual and at a distance of about 17 cm from the concave lens.
 - (b) real and at a distance of about 47 cm from the object.
 - (c) virtual, diminished and at a distance of 10 cm from the concave lens.
 - (d) real and at a distance of 57 cm from the object.
59. Now consider again the lenses to be in contact with each other but made of material of refractive index 1.2. The system is immersed in a medium of refractive index μ and it is found that the focal length of the system remains numerically the same as when in air. Therefore, μ is
- (a) less than 1.2
 - (b) between 1.2 and 1.5
 - (c) greater than 1.5
 - (d) equal to 1.5
60. The given convex lens (refractive index $\frac{3}{2}$) is made to rest on the surface of a lake such that its upper surface is in air while the lower one is in water (refractive index $\frac{4}{3}$). Rays from the sun overhead converge at a distance ' a ' inside the water, while rays from a luminescent anglerfish beneath at the bottom of the lake converge at a distance ' b ' in air. Therefore,
- (a) $a = 12$ cm, $b = 12$ cm
 - (b) $a = 24$ cm, $b = 12$ cm
 - (c) $a = 18$ cm, $b = 12$ cm
 - (d) $a = 24$ cm, $b = 18$ cm

A 2

In Q. Nos. 61 to 70 any number of options (1 or 2 or 3 or all 4) may be correct. You are to identify all of them correctly to get 6 marks. Even if one answer identified is incorrect or one correct answer is missed, you get zero marks.

61. Four point masses are placed in a plane so that their centre of mass is at (1,1). Three of them are of mass m each and are placed at (0,0), (2,0) and (0,2) respectively. The fourth point of mass $2m$ is displaced from its initial position such that centre of mass of the system moves to (2,1). Then, the displacement of the fourth point mass is
- (a) parallel to X axis. (b) inclined at an angle 45° with X axis.
 (c) of magnitude $\frac{5}{2}$ units. (d) of magnitude 5 units.
62. A block A of mass 2 kg rests on a horizontal surface. Another block B of mass 1 kg moving at a speed of 1 m/s when at a distance of 16 cm from A, collides elastically with A. The coefficient of friction between the horizontal surface and each of the blocks is 0.2. Then, ($g = 10 \text{ m/s}^2$),
- (a) after collision block B rebounds.
 (b) after collision block B comes to rest.
 (c) final separation between the blocks is 3 cm.
 (d) final separation between the blocks is 5 cm.
63. A uniform disc of mass M and radius R is lifted using a string as shown in the figure. Then,

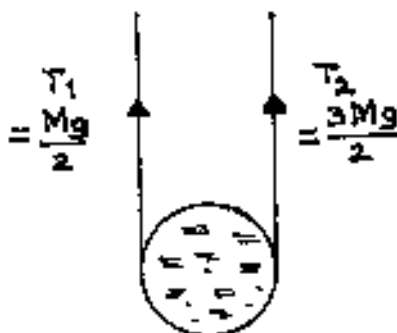

- (a) its linear acceleration is g upward. (b) its linear acceleration is g downward.
 (c) its angular acceleration is $\frac{2g}{R}$. (d) its rate of change of angular momentum is MgR .

Q. P. Code - P 152

64. Four thin straight long wires are all parallel to Z axis. They pass through the points A(3,0,0), B(0,3,0), C(-3,0,0) and D(0,-3,0). They all carry currents in \hat{k} direction of magnitudes 0.3 A, 0.6 A, 0.3 A and 0.3 A respectively. The magnitude of magnetic field at the origin O due to
- (a) wires at A and C is zero. (b) wires at A and B is $2\sqrt{2} \times 10^{-8}$ T
 (c) wires at A and D is $2\sqrt{2} \times 10^{-8}$ T (d) all wires is 2×10^{-8} T
65. In a drip irrigation system water flows at 0.4 m/s through a 25 mm diameter pipe. At each of the plants in the field water is expected to be delivered at 0.02 m/s through a 2 mm opening. The drip works for 2 hours a day. Then,
- (a) the system feeds 2250 plants.
 (b) a plant gets about 3.2 litres of water a day.
 (c) the system feeds 3125 plants.
 (d) a plant gets about 1.8 litres of water a day.
66. Refer to the circuit given below. Output voltage V_0 is measured between points **a** and **b**. Then,

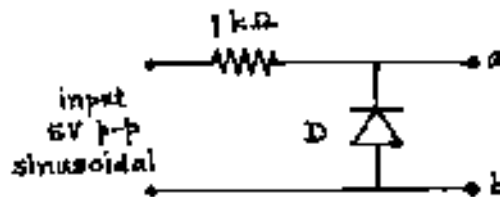

- (a) the peak value of V_0 is 2.5 volt above the minimum if the diode is assumed to be ideal.
 (b) the positive half cycle of the input is clipped.
 (c) the circuit acts as a rectifier.
 (d) the peak value of V_0 is about 3.2 volt above the minimum if D is silicon diode (non-ideal).
67. Two constant volume gas thermometers – one containing helium and the other containing oxygen are used to measure the boiling point of liquid nitrogen. For calibrating the He thermometer first it is dipped in boiling water and afterwards in boiling liquid nitrogen and the pressure was found to change by a factor of 5. The process is repeated with oxygen thermometer. Then, which of the following statement/s is/are true?
- (a) According to He thermometer liquid nitrogen boils at 74.6 K.
 (b) Oxygen gas thermometer also gives the same result.
 (c) Oxygen gas thermometer cannot be used in this situation.
 (d) Helium gas thermometer cannot give the linear variation of pressure with temperature.

Q. P. Code - P 152

68. A hollow prism filled with hot water is used with usual arrangement to obtain a spectrum. The water prism is set in minimum deviation position. It is observed that the spectrum shifts so that deviation increases. Indicate the correct statement/s.
- (a) Refractive index of water increases with decrease of temperature.
 - (b) Refractive index of water increases with increase of temperature.
 - (c) Speed of light decreases with decrease of temperature.
 - (d) Speed of light increases with decrease of temperature.
69. A vertical narrow wire is illuminated with laser. Alternate dark and bright bands are formed on a graph paper pasted on a distant wall. Indicate the correct statement/s.
- (a) Making appropriate measurements it is possible to determine the diameter of the wire.
 - (b) This phenomenon exhibits that light does not follow rectilinear paths.
 - (c) This is a case of Fraunhofer diffraction.
 - (d) This is a case of interference of an infinitely large number of Huygens' secondary waves leading to a diffraction pattern.
70. Consider an element of a stretched string along which a wave travels. During its transverse oscillatory motion, the element passes through a point at $y = 0$ and reaches its maximum at $y = y_m$. Then, the string element has its maximum
- (a) kinetic energy at $y = y_m$.
 - (b) elastic potential energy at $y = y_m$.
 - (c) kinetic energy at $y = 0$.
 - (d) elastic potential energy at $y = 0$.

-X-X-X-X-X-X-X-X-X-

Physical constants you may need...

Charge on electron $e = 1.6 \times 10^{-19}$ C

Mass of electron $m_e = 9.1 \times 10^{-31}$ kg

Universal gravitational constant $G = 6.67 \times 10^{-11}$ Nm²/kg²

Permittivity of free space $\epsilon_0 = 8.85 \times 10^{-12}$ C²/Nm²

Universal gas constant $R = 8.31$ J/mol K

Planck constant $h = 6.62 \times 10^{-34}$ Js

Stefan constant $\sigma = 5.67 \times 10^{-8}$ W/m²K⁴

Boltzmann constant $k = 1.38 \times 10^{-23}$ J/K

Mass of proton $m_p = 1.67 \times 10^{-27}$ kg

Boiling point of nitrogen = 77.4 K

Boiling point of oxygen = 90.19 K

Boiling point of hydrogen = 20.3 K Boiling point of helium = 4.2 K