

Important Instructions:

1. The test is of **3 hours duration**.
2. The Test Booklet consists of **90** questions. The maximum marks are **360**.
3. There are **three** parts in the question paper A, B, C consisting of **Physics, Mathematics** and **Chemistry** having 30 questions in each part of equal weightage. Each question is allotted **4 (four)** marks for correct response.
4. *Candidates will be awarded marks as stated above in instruction No. 3 for correct response of each question. (1/4) (one fourth) marks will be deducted for indicating incorrect response of each question. No deduction from the total score will be made if no response is indicated for an item in the answer sheet.*
5. There is only one correct response for each question. Filling up more than one response in each question will be treated as wrong response and marks for wrong response will be deducted accordingly as per instruction 4 above.

PART - A: PHYSICS

1. The pressure that has to be applied to the ends of a steel wire of length 10 cm to keep its length constant when its temperature is raised by 100°C is :

(For steel Young's modulus is $2 \times 10^{11} \text{ N m}^{-2}$ and coefficient of thermal expansion is $1.1 \times 10^{-5} \text{ K}^{-1}$)

- (1) $2.2 \times 10^7 \text{ Pa}$ (2) $2.2 \times 10^6 \text{ Pa}$
 (3) $2.2 \times 10^8 \text{ Pa}$ (4) $2.2 \times 10^9 \text{ Pa}$

Sol. 3

$$0.10 \times 1.1 \times 10^{-5} \times 100 = \frac{F}{2 \times 10^{11}} \times 0.10$$

$$\therefore \frac{F}{A} = \text{Pressure} = 1.1 \times 10^{-5} \times 100 \times 2 \times 10^{11} = 2.2 \times 10^8 \text{ Pa}$$

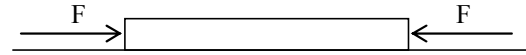

2. A conductor lies along the z-axis at $-1.5 \leq z < 1.5 \text{ m}$ and carries a fixed current of 10.0 A in $-\hat{a}_z$ direction (see figure). For a field $\vec{B} = 3.0 \times 10^{-4} e^{-0.2x} \hat{a}_y \text{ T}$, find the power required to move the conductor at constant speed to $x = 2.0 \text{ m}$, $y = 0 \text{ m}$ in $5 \times 10^{-3} \text{ s}$. Assume parallel motion along the x-axis

(1) 14.85 W (2) 29.7 W
 (3) 1.57 W (4) 2.97 W

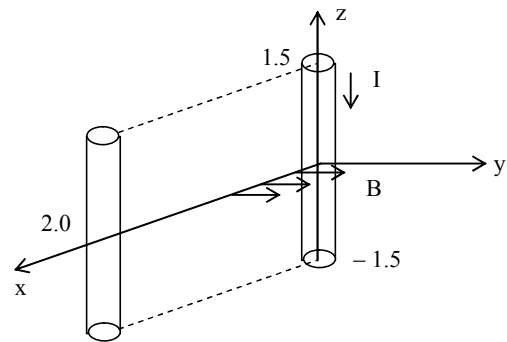

Sol. 4

$$P = \frac{\text{Work Done}}{\text{Time}} = \frac{\int F dx}{t} = \frac{\int I l b B dx}{t}$$

$$= \frac{\int_0^2 (10)(3)(3 \times 10^{-4} e^{-0.2x}) dx}{5 \times 10^{-3}}$$

$$= \frac{9 \times 10^{-3}}{5 \times 10^{-3}} \left[\frac{e^{-0.2x}}{-0.2} \right]_0^2 = 9 [1 - e^{-0.4}] = 2.97 \text{ W}$$

3. A bob of mass m attached to an inextensible string of length ℓ is suspended from a vertical support. The bob rotates in a horizontal circle with an angular speed $\omega \text{ rad/s}$ about the vertical. About the point of suspension :

- (1) angular momentum changes in direction but not in magnitude.
 (2) angular momentum changes both in direction and magnitude.
 (3) angular momentum is conserved.
 (4) angular momentum changes in magnitude but not in direction.

Sol. 1

\vec{L} changes in direction not in magnitude

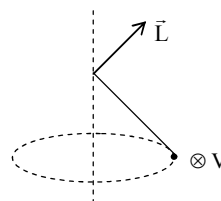

4. The current voltage relation of diode is given by $I = (e^{1000V/T} - 1) \text{ mA}$, where the applied voltage V is in volts and the temperature T is in degree Kelvin. If a student makes an error measuring $\pm 0.01 \text{ V}$ while measuring the current of 5 mA at 300 K, what will be the error in the value of current in mA ?

- (1) 0.5 mA (2) 0.05 mA
 (3) 0.2 mA (4) 0.02 mA

Sol. (3)

$$5 = e^{\frac{1000V}{T}} - 1$$

$$\Rightarrow e^{\frac{1000V}{T}} = 6 \quad \dots(1)$$

Again, $I = e^{\frac{1000V}{T}} - 1$

$$\frac{dI}{dV} = e^{\frac{1000V}{T}} \frac{1000}{T}$$

$$dI = \frac{1000}{T} e^{\frac{1000V}{T}} dV$$

Using (1)

$$\Delta I = \frac{1000}{T} \times 6 \times 0.01 = \frac{60}{T} = \frac{60}{300} = 0.2\text{mA}$$

5. An open glass tube is immersed in mercury in such a way that a length of 8 cm extends above the mercury level. The open end of the tube is then closed and sealed and the tube is raised vertically up by additional 46 cm. What will be length of the air column above mercury in the tube now? (Atmospheric pressure = 76 cm of Hg)

- (1) 38 cm (2) 6 cm
 (3) 16 cm (4) 22 cm

Sol. (3)

$$(76 - 8) = (54 - x)(76 - x)$$

$$x = 38 \text{ cm}$$

$$\text{Length of air column} = 54 - 38 = 16 \text{ cm}$$

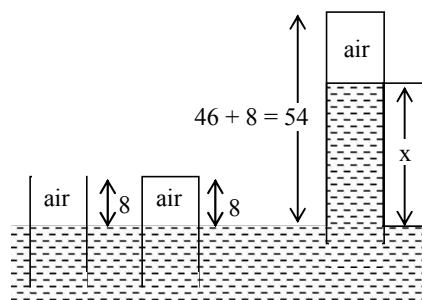

6. Match **List-I** (Electromagnetic wave type) with **List-II** (Its association / application) and select the correct option from the choices given below the lists:

List – I		List – II	
(a)	Infrared waves	(i)	To treat muscular strain
(b)	Radio waves	(ii)	For broadcasting
(c)	X-rays	(iii)	To detect fracture of bones
(d)	Ultraviolet rays	(iv)	Absorbed by the ozone layer of the atmosphere

- | | | | |
|-----------|-------|-------|-------|
| (a) | (b) | (c) | (d) |
| (1) (iii) | (ii) | (i) | (iv) |
| (2) (i) | (ii) | (iii) | (iv) |
| (3) (iv) | (iii) | (ii) | (i) |
| (4) (i) | (ii) | (iv) | (iii) |

Sol. 2

Infrared waves → To treat muscular strain

radio waves → for broadcasting

X-rays → To detect fracture of bones

Ultraviolet rays → Absorbed by the ozone layer of the atmosphere;

7. A parallel plate capacitor is made of two circular plates separated by a distance of 5 mm and with a dielectric of dielectric constant 2.2 between them. When the electric field in the dielectric is $3 \times 10^4 \text{ V/m}$, the charge density of the positive plate will be close to :

- (1) $3 \times 10^4 \text{ C/m}^2$ (2) $6 \times 10^4 \text{ C/m}^2$
 (3) $6 \times 10^{-7} \text{ C/m}^2$ (4) $3 \times 10^{-7} \text{ C/m}^2$

Sol. 3

By formula of electric field between the plates of a capacitor $E = \frac{\sigma}{K\epsilon_0}$

$$\begin{aligned} \Rightarrow \sigma &= EK\epsilon_0 = 3 \times 10^4 \times 2.2 \times 8.85 \times 10^{-12} \\ &= 6.6 \times 8.85 \times 10^{-8} \\ &= 5.841 \times 10^{-7} \\ &\cong 6 \times 10^{-7} \text{ C/m}^2 \end{aligned}$$

8. A student measured the length of a rod and wrote it as 3.50 cm. Which instrument did he use to measure it?
- (1) A screw gauge having 100 divisions in the circular scale and pitch as 1 mm.
 - (2) A screw gauge having 50 divisions in the circular scale and pitch as 1 mm.
 - (3) A meter scale.
 - (4) A vernier calliper where the 10 divisions in vernier scale matches with 9 division in main scale and main scale has 10 divisions in 1 cm.

Sol. 4

Least count of vernier calliper is $\frac{1}{10} \text{ mm} = 0.1 \text{ mm} = 0.01 \text{ cm}$

9. Four particles, each of mass M and equidistant from each other, move along a circle of radius R under the action of their mutual gravitational attraction. The speed of each particle is :

- (1) $\sqrt{\frac{GM}{R}(1+2\sqrt{2})}$
- (2) $\frac{1}{2} \sqrt{\frac{GM}{R}(1+2\sqrt{2})}$
- (3) $\sqrt{\frac{GM}{R}}$
- (4) $\sqrt{2\sqrt{2} \frac{GM}{R}}$

Sol. 2

Net force on any one particle

$$\begin{aligned} &= \frac{GM^2}{(2R)^2} + \frac{GM^2}{(R\sqrt{2})^2} \cos 45^\circ + \frac{GM^2}{(R\sqrt{2})^2} \cos 45^\circ \\ &= \frac{GM^2}{R^2} \left[\frac{1}{4} + \frac{1}{\sqrt{2}} \right] \end{aligned}$$

This force will be equal to centripetal force so

$$\begin{aligned} \frac{Mu^2}{R} &= \frac{GM^2}{R^2} \left[\frac{1+2\sqrt{2}}{4} \right] \\ u &= \sqrt{\frac{GM}{4R} [1+2\sqrt{2}]} = \frac{1}{2} \sqrt{\frac{GM}{R} (2\sqrt{2}+1)} \end{aligned}$$

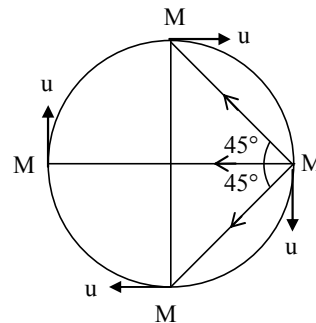

10. In a large building, there are 15 bulbs of 40 W, 5 bulbs of 100 W, 5 fans of 80 W and 1 heater of 1kW. The voltage of the electric mains is 220 V. The minimum capacity of the main fuse of the building will be :

- (1) 12 A
- (2) 14 A
- (3) 8 A
- (4) 10 A

Sol. 1

Item	No.	Power
40 W bulb	15	600 Watt
100 W bulb	5	500 Watt
80 W fan	5	400 Watt
1000 W heater	1	1000 Watt

Total Wattage = 2500 Watt

$$\text{So current capacity } i = \frac{P}{V} = \frac{2500}{220} = \frac{125}{11} = 11.36 \cong 12 \text{ Amp.}$$

11. A particle moves with simple harmonic motion in a straight line. In first τ s, after starting from rest it travels a distance a , and in next τ s it travels $2a$, in same direction, then :
- (1) amplitude of motion is $4a$ (2) time period of oscillations is 6τ
 (3) amplitude of motion is $3a$ (4) time period of oscillations is 8τ

Sol.

2

$$A(1 - \cos \omega\tau) = a$$

$$A(1 - \cos 2\omega\tau) = 3a$$

$$\cos \omega\tau = \left(1 - \frac{a}{A}\right)$$

$$\cos 2\omega\tau = \left(1 - \frac{3a}{A}\right)$$

$$2\left(1 - \frac{a}{A}\right)^2 - 1 = 1 - \frac{3a}{A}$$

Solving the equation

$$\frac{a}{A} = \frac{1}{2}$$

$$A = 2a$$

$$\cos \omega\tau = \frac{1}{2}$$

$$T = 6\tau$$

12. The coercivity of a small magnet where the ferromagnet gets demagnetized is $3 \times 10^3 \text{ Am}^{-1}$. The current required to be passed in a solenoid of length 10 cm and number of turns 100, so that the magnet gets demagnetized when inside the solenoid, is:
- (1) 3A (2) 6A
 (3) 30 mA (4) 60 mA

Sol.

1

$$\mu_0 H = \mu_0 ni$$

$$3 \times 10^3 = \frac{100}{0.1} \times i \Rightarrow i = 3A$$

13. The forward biased diode connection is:

(1)		(2)	
(3)		(4)	

Sol.

3
By diagram

14. During the propagation of electromagnetic waves in a medium:
- (1) Electric energy density is equal to the magnetic energy density.
 (2) Both electric and magnetic energy densities are zero.
 (3) Electric energy density is double of the magnetic energy density.
 (4) Electric energy density is half of the magnetic energy density.

Sol.

1

15. In the circuit shown here, the point 'C' is kept connected to point 'A' till the current flowing through the circuit becomes constant. Afterward, suddenly, point 'C' is disconnected from point 'A' and connected to point 'B' at time $t = 0$. Ratio of the voltage across resistance and the inductor at $t = L/R$ will be equal to :

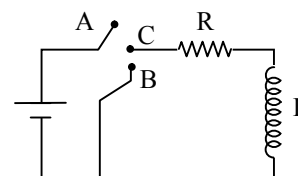

- (1) -1 (2) $\frac{1-e}{e}$
 (3) $\frac{e}{1-e}$ (4) 1

Sol. 4
 Since resistance and inductor are in parallel, so ratio will be 1.

16. A mass 'm' is supported by a massless string wound around a uniform hollow cylinder of mass m and radius R. If the string does not slip on the cylinder, with what acceleration will the mass fall on release?

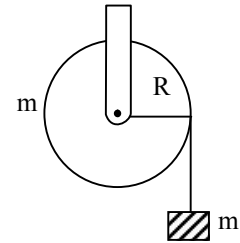

- (1) $\frac{5g}{6}$ (2) g
 (3) $\frac{2g}{3}$ (4) $\frac{g}{2}$

Sol. 4
 For the mass m,
 $mg - T = ma$
 for the cylinder,

$$TR = mR^2 \frac{a}{R}$$

$$\Rightarrow T = ma$$

$$\Rightarrow mg = 2ma$$

$$\Rightarrow a = g/2$$

17. One mole of diatomic ideal gas undergoes a cyclic process ABC as shown in figure. The process BC is adiabatic. The temperatures at A, B and C are 400 K, 800 K and 600 K respectively. Choose the correct statement:

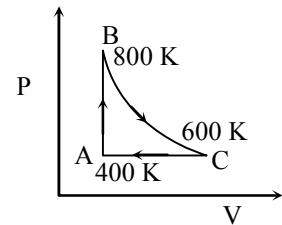

- (1) The change in internal energy in the process AB is $-350 R$.
 (2) The change in internal energy in the process BC is $-500 R$.
 (3) The change in internal energy in whole cyclic process is $250 R$.
 (4) The change in internal energy in the process CA is $700 R$.

Sol. 2

$$\Delta U_{AB} = nC_v(T_B - T_A) = 1 \times \frac{5R}{2}(800 - 400) = 1000 R$$

$$\Delta U_{BC} = nC_v(T_C - T_B) = 1 \times \frac{5R}{2}(600 - 800) = -500 R$$

$$\Delta U_{total} = 0$$

$$\Delta U_{CA} = nC_v(T_A - T_C) = 1 \times \frac{5R}{2}(400 - 600) = -500 R$$

18. From a tower of height H, a particle is thrown vertically upwards with a speed u. The time taken by the particle, to hit the ground, is n times that taken by it to reach the highest point of its path. The relation between H, u and n is:

- (1) $2gH = nu^2(n - 2)$ (2) $gH = (n - 2)u^2$
 (3) $2gH = n^2u^2$ (4) $gH = (n - 2)^2u^2$

Sol. 1

Time to reach the maximum height

$$t_1 = \frac{u}{g}$$

If t_2 be the time taken to hit the ground

$$-H = ut_2 - \frac{1}{2}gt_2^2$$

But $t_2 = nt_1$ (given)

$$\Rightarrow -H = u \frac{nu}{g} - \frac{1}{2}g \frac{n^2u^2}{g^2}$$

$$\Rightarrow 2gH = nu^2(n - 2)$$

19. A thin convex lens made from crown glass ($\mu = \frac{3}{2}$) has focal length f . When it is measured in two different liquids having refractive indices $\frac{4}{3}$ and $\frac{5}{3}$, it has the focal lengths f_1 and f_2 respectively. The correct relation between the focal lengths is:

- (1) $f_2 > f$ and f_1 becomes negative
 (2) f_1 and f_2 both become negative
 (3) $f_1 = f_2 < f$
 (4) $f_1 > f$ and f_2 becomes negative

Sol.

4

$$\frac{f_m}{f} = \frac{(\mu - 1)}{\left(\frac{\mu}{\mu_m} - 1\right)}$$

$$\Rightarrow \frac{f_1}{f} = \frac{\left(\frac{3}{2} - 1\right)}{\left(\frac{3/2}{4/3} - 1\right)} = 4$$

$$\Rightarrow f_1 = 4f$$

$$\frac{f_2}{f} = \frac{\left(\frac{3}{2} - 1\right)}{\left(\frac{3/2}{5/3} - 1\right)} = -5$$

$$\Rightarrow f_2 < 0$$

20. Three rods of Copper, Brass and Steel are welded together to form a Y-shaped structure. Area of cross-section of each rod = 4 cm^2 . End of copper rod is maintained at 100°C where as ends of brass and steel are kept at 0°C . Lengths of the copper, brass and steel rods are 46, 13 and 12 cms respectively. The rods are thermally insulated from surroundings except at ends. Thermal conductivities of copper, brass and steel are 0.92, 0.26 and 0.12 CGS units respectively. Rate of heat flow through copper rod is :

- (1) 4.8 cal/s
 (2) 6.0 cal/s
 (3) 1.2 cal/s
 (4) 2.4 cal/s

Sol.

1

$$\frac{dQ_1}{dt} = \frac{dQ_2}{dt} + \frac{dQ_3}{dt}$$

$$\Rightarrow \frac{0.92(100 - T)}{46} = \frac{0.26(T - 0)}{13} + \frac{0.12(T - 0)}{12}$$

$$\Rightarrow T = 40^\circ\text{C}$$

$$\frac{dQ_1}{dt} = \frac{0.92 \times 4(100 - 40)}{46} = 4.8 \text{ cal/s}$$

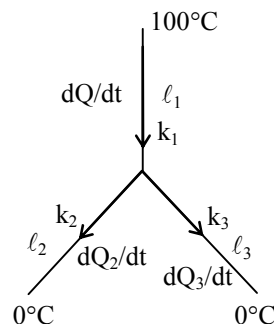

21. A pipe of length 85 cm is closed from one end. Find the number of possible natural oscillations of air column in the pipe whose frequencies lie below 1250 Hz. The velocity of sound in air is 340 m/s.

- (1) 6
 (2) 4
 (3) 12
 (4) 8

Sol.

1

In fundamental mode

$$\frac{\lambda}{4} = 0.85$$

$$\lambda = 4 \times 0.85$$

$$f = v/\lambda = \frac{340}{4 \times 0.85}$$

$$= 100 \text{ Hz.}$$

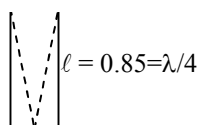

\therefore Possible frequencies = 100 Hz, 300 Hz, 500 Hz, 700 Hz, 900 Hz, 1100 Hz below 1250 Hz.

22. There is a circular tube in a vertical plane. Two liquids which do not mix and of densities d_1 and d_2 are filled in the tube. Each liquid subtends 90° angle at centre. Radius joining their interface makes an angle α with vertical. ratio d_1/d_2 is

- (1) $\frac{1 + \tan \alpha}{1 - \tan \alpha}$ (B) $\frac{1 + \sin \alpha}{1 - \cos \alpha}$
 (3) $\frac{1 + \sin \alpha}{1 - \sin \alpha}$ (D) $\frac{1 + \cos \alpha}{1 - \cos \alpha}$

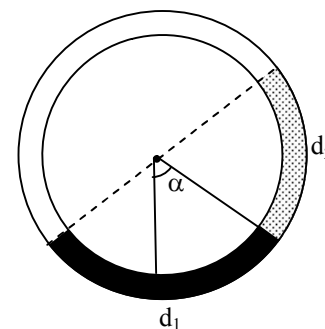

Sol.

1
 $P_A = P_B$
 $P_0 + d_1 g R (\cos \alpha - \sin \alpha) = P_0 + d_2 g R (\cos \alpha + \sin \alpha)$
 $\Rightarrow \frac{d_1}{d_2} = \frac{\cos \alpha + \sin \alpha}{\cos \alpha - \sin \alpha} = \frac{1 + \tan \alpha}{1 - \tan \alpha}$

23. A green light is incident from the water to the air – water interface at the critical angle (θ). Select the correct statement

- (1) The spectrum of visible light whose frequency is more than that of green light will come out to the air medium.
 (2) The entire spectrum of visible light will come out of the water at various angles to the normal.
 (3) The entire spectrum of visible light will come out of the water at an angle of 90° to the normal.
 (4) The spectrum of visible light whose frequency is less than that of green light will come out to the air medium.

Sol.

4
 As frequency of visible light increases refractive index increases. With the increase of refractive index critical angle decreases. So that light having frequency greater than green will get total internal reflection and the light having frequency less than green will pass to air.

24. Hydrogen (${}_1\text{H}^1$), Deuterium (${}_1\text{H}^2$), singly ionised Helium (${}_2\text{He}^4$)⁺ and doubly ionised lithium (${}_3\text{Li}^6$)⁺⁺ all have one electron around the nucleus. Consider an electron transition from $n = 2$ to $n = 1$. If the wave lengths of emitted radiation are $\lambda_1, \lambda_2, \lambda_3$ and λ_4 respectively then approximately which one of the following is correct?

- (1) $\lambda_1 = \lambda_2 = 4\lambda_3 = 9\lambda_4$ (2) $\lambda_1 = 2\lambda_2 = 3\lambda_3 = 4\lambda_4$
 (3) $4\lambda_1 = 2\lambda_2 = 2\lambda_3 = \lambda_4$ (4) $\lambda_1 = 2\lambda_2 = 2\lambda_3 = \lambda_4$

Sol.

1
 $\frac{1}{\lambda} = RZ^2 \left(\frac{1}{1^2} - \frac{1}{2^2} \right)$
 $\therefore \lambda = \frac{4}{3RZ^2}$
 $\lambda_1 = \frac{4}{3R}$
 $\lambda_2 = \frac{4}{3R}$
 $\lambda_3 = \frac{4}{12R}$
 $\lambda_4 = \frac{4}{27R}$
 $\Rightarrow \lambda_1 = \lambda_2 = 4\lambda_3 = 9\lambda_4$

25. The radiation corresponding to $3 \rightarrow 2$ transition of hydrogen atom falls on a metal surface to produce photoelectrons. These electrons are made to enter a magnetic field of $3 \times 10^{-4}\text{T}$. If the radius of the largest circular path followed by these electrons is 10.0 mm, the work function of the metal is close to :

- (1) 0.8 eV (2) 1.6 eV
 (3) 1.8 eV (4) 1.1 eV

Sol.

$$\begin{aligned}
 &4 \\
 &mv = qBR \\
 &KE_{(\max)} = \frac{(mv)^2}{2m} = 0.8\text{eV} \\
 &hv = 13.6 \left[\frac{1}{4} - \frac{1}{9} \right] \\
 &\therefore W = hv - KE_{(\max)} \\
 &= 13.6 \frac{5}{36} - 0.8 = 1.1\text{eV}
 \end{aligned}$$

26. A block of mass m is placed on a surface with a vertical cross section given by $y = x^3/6$. If the coefficient of friction is 0.5, the maximum height above the ground at which the block can be placed without slipping is :

- (1) $\frac{1}{3}m$ (2) $\frac{1}{2}m$
 (3) $\frac{1}{6}m$ (4) $\frac{2}{3}m$

Sol.

$$\begin{aligned}
 &3 \\
 &mg \sin \theta = \mu mg \cos \theta \\
 &\tan \theta = \mu \\
 &\frac{dy}{dx} = \tan \theta = \mu = \frac{1}{2} \\
 &\frac{x^2}{2} = \frac{1}{2}, \quad x = \pm 1 \\
 &y = \frac{1}{6}m.
 \end{aligned}$$

27. When a rubber-band is stretched by a distance x , it exerts a restoring force of magnitude $F = ax + bx^2$ where a and b are constants. The work done in stretching the unstretched rubber band by L is :

- (1) $\frac{aL^2}{2} + \frac{bL^3}{3}$ (2) $\frac{1}{2} \left(\frac{aL^2}{2} + \frac{bL^3}{3} \right)$
 (3) $aL^2 + bL^3$ (4) $\frac{1}{2} (aL^2 + bL^3)$

Sol.

$$\begin{aligned}
 &1 \\
 &F = ax + bx^2 \\
 &dw = Fdx \\
 &W = \int_0^L (ax + bx^2) dx \\
 &W = \frac{aL^2}{2} + \frac{bL^3}{3}
 \end{aligned}$$

28. On heating water, bubbles being formed at the bottom of the vessel detach and rise. Take the bubbles to be spheres of radius R and making a circular contact of radius r with the bottom of the vessel. If $r \ll R$, and the surface tension of water is T , value of r just before bubbles detach is : (density of water is ρ_w)

- (1) $R^2 \sqrt{\frac{\rho_w g}{T}}$ (2) $R^2 \sqrt{\frac{3\rho_w g}{T}}$
 (3) $R^2 \sqrt{\frac{\rho_w g}{3T}}$ (4) $R^2 \sqrt{\frac{\rho_w g}{6T}}$

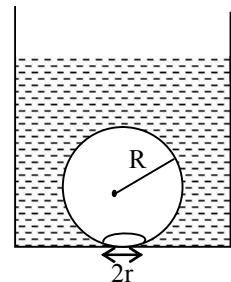

Sol.

None

$$(2\pi r T)\sin \theta = \frac{4}{3}\pi R^3 \rho_w g$$

$$T \times \frac{r}{R} \times 2\pi r = \frac{4}{3}\pi R^3 \rho_w g$$

$$r^2 = \frac{2 R^4 \rho_w g}{3 T}$$

$$r = R^2 \sqrt{\frac{2\rho_w g}{3T}}$$

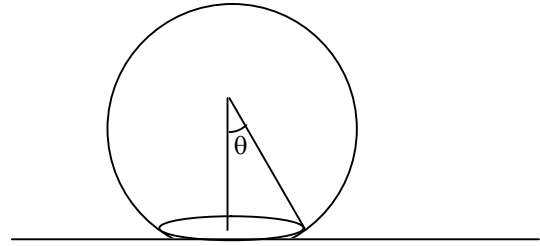

29. Two beams, A and B, of plane polarized light with mutually perpendicular planes of polarization are seen through a polaroid. From the position when the beam A has maximum intensity (and beam B has zero intensity), a rotation of Polaroid through 30° makes the two beams appear equally bright. If the initial intensities of the two beams are I_A and I_B respectively, then I_A/I_B equals :

- (1) 1 (2) 1/3
 (3) 3 (4) 3/2

Sol.

$$I_A \cos^2 30 = I_B \cos^2 60$$

$$\frac{I_A}{I_B} = \frac{1}{3}$$

30. Assume that an electric field $\vec{E} = 30x^2\hat{i}$ exists in space. Then the potential difference $V_A - V_O$, where V_O is the potential at the origin and V_A the potential at $x = 2$ m is :

- (1) -80 J (2) 80 J
 (3) 120 J (4) -120 J

Sol.

None

$$\vec{E} = 30x^2\hat{i}$$

$$dV = - \int E \cdot dx$$

$$\int_{V_0}^{V_A} dV = - \int_0^2 30x^2 dx$$

$$V_A - V_0 = -80 \text{ Volt}$$

PART - B: MATHEMATICS

31. The image of the line $\frac{x-1}{3} = \frac{y-3}{1} = \frac{z-4}{-5}$ in the plane $2x - y + z + 3 = 0$ is the line

- (1) $\frac{x+3}{3} = \frac{y-5}{1} = \frac{z-2}{-5}$ (2) $\frac{x+3}{-3} = \frac{y-5}{-1} = \frac{z+2}{5}$
 (3) $\frac{x-3}{3} = \frac{y+5}{1} = \frac{z-2}{-5}$ (4) $\frac{x-3}{-3} = \frac{y+5}{-1} = \frac{z-2}{5}$

Sol.

1
 Line is parallel to plane
 Image of (1, 3, 4) is (-3, 5, 2).

32. If the coefficients of x^3 and x^4 in the expansion of $(1 + ax + bx^2)(1 - 2x)^{18}$ in powers of x are both zero, then (a, b) is equal to

- (1) $(16, \frac{251}{3})$ (2) $(14, \frac{251}{3})$
 (3) $(14, \frac{272}{3})$ (4) $(16, \frac{272}{3})$

Sol.

4
 $1(1 - 2x)^{18} + ax(1 - 2x)^{18} + bx^2(1 - 2x)^{18}$
 Coefficient of x^3 : $(-2)^3 {}^{18}C_3 + a(-2)^2 {}^{18}C_2 + b(-2) {}^{18}C_1 = 0$
 $\frac{4 \times (17 \times 16)}{(3 \times 2)} - 2a \cdot \frac{17}{2} + b = 0$ (i)
 Coefficient of x^4 : $(-2)^4 {}^{18}C_4 + a(-2)^3 {}^{18}C_3 + b(-2)^2 {}^{18}C_2 = 0$
 $(4 \times 20) - 2a \cdot \frac{16}{3} + b = 0$ (ii)

From equation (i) and (ii), we get

$$4\left(\frac{17 \times 8}{3} - 20\right) + 2a\left(\frac{16}{3} - \frac{17}{2}\right) = 0$$

$$4\left(\frac{17 \times 8 - 60}{3}\right) + \frac{2a(-19)}{6} = 0$$

$$a = \frac{4 \times 76 \times 6}{3 \times 2 \times 19}$$

$$\Rightarrow a = 16$$

$$\Rightarrow b = \frac{2 \times 16 \times 16}{3} - 80 = \frac{272}{3}$$

33. If $a \in \mathbb{R}$ and the equation $-3(x - [x])^2 + 2(x - [x]) + a^2 = 0$ (where $[x]$ denotes the greatest integer $\leq x$) has no integral solution, then all possible values of a lie in the interval

- (1) $(-1, 0) \cup (0, 1)$ (2) $(1, 2)$
 (3) $(-2, -1)$ (4) $(-\infty, -2) \cup (2, \infty)$

Sol.

1
 $a^2 = 3t^2 - 2t$
 For non-integral solution
 $0 < a^2 < 1$
 $a \in (-1, 0) \cup (0, 1)$.

[Note: It is assumed that a real solution of given equation exists.]

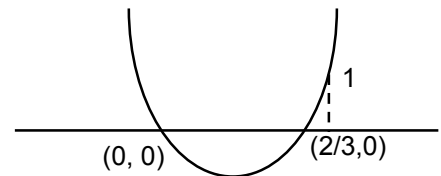

34. If $[\vec{a} \times \vec{b} \quad \vec{b} \times \vec{c} \quad \vec{c} \times \vec{a}] = \lambda [\vec{a} \quad \vec{b} \quad \vec{c}]^2$, then λ is equal to

- (1) 2 (2) 3
 (3) 0 (4) 1

Sol. 4

$$[\vec{a} \times \vec{b} \quad \vec{b} \times \vec{c} \quad \vec{c} \times \vec{a}] = [\vec{a} \ \vec{b} \ \vec{c}]^2$$

$$\lambda = 1.$$

35. The variance of first 50 even natural numbers is

- (1) $\frac{833}{4}$ (2) 833
 (3) 437 (4) $\frac{437}{4}$

Sol. 2

$$\sigma^2 = \left(\frac{\sum x_i^2}{n} \right) - \bar{x}^2$$

$$\bar{x} = \frac{\sum_{r=1}^{50} 2r}{50} = 51$$

$$\sigma^2 = \frac{\sum_{r=1}^{50} 4r^2}{50} - (51)^2 = 833$$

36. A bird is sitting on the top of a vertical pole 20 m high and its elevation from a point O on the ground is 45°. It flies off horizontally straight away from the point O. After one second, the elevation of the bird from O is reduced to 30°. Then the speed (in m/s) of the bird is

- (1) $40(\sqrt{2} - 1)$ (2) $40(\sqrt{3} - \sqrt{2})$
 (3) $20\sqrt{2}$ (4) $20(\sqrt{3} - 1)$

Sol. 4

$$\tan 30^\circ = \frac{20}{20+x} = \frac{1}{\sqrt{3}}$$

$$20+x = 20\sqrt{3}$$

$$x = 20(\sqrt{3} - 1)$$

⇒ Speed is $20(\sqrt{3} - 1)$ m/sec.

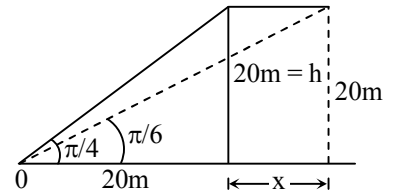

37. The integral $\int_0^{\pi} \sqrt{1 + 4 \sin^2 \frac{x}{2} - 4 \sin \frac{x}{2}} dx$ equals

- (1) $\pi - 4$ (2) $\frac{2\pi}{3} - 4 - 4\sqrt{3}$
 (3) $4\sqrt{3} - 4$ (4) $4\sqrt{3} - 4 - \frac{\pi}{3}$

Sol. 4

$$I = \int_0^{\pi} \sqrt{1 + 4 \sin^2 \frac{x}{2} - 4 \sin \frac{x}{2}} dx$$

$$= \int_0^{\pi} |1 - 2 \sin \frac{x}{2}| dx$$

$$= \int_0^{\pi/3} (1 - 2 \sin \frac{x}{2}) dx + \int_{\pi/3}^{\pi} (2 \sin \frac{x}{2} - 1) dx$$

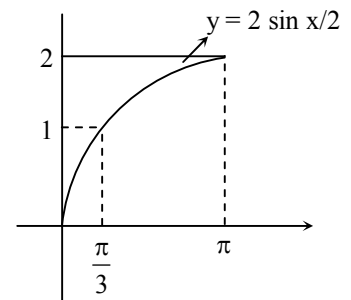

$$\begin{aligned}
 &= \left(x + 4 \cos \frac{x}{2} \right) \Big|_0^{\pi/3} + \left(-4 \cos \frac{x}{2} - x \right) \Big|_{\pi/3}^{\pi} \\
 &= -\frac{\pi}{3} + 8 \cdot \frac{\sqrt{3}}{2} - 4 \\
 &= 4\sqrt{3} - 4 - \frac{\pi}{3}
 \end{aligned}$$

38. The statement $\sim(p \leftrightarrow \sim q)$ is
 (1) equivalent to $p \leftrightarrow q$ (2) equivalent to $\sim p \leftrightarrow q$
 (3) a tautology (4) a fallacy

Sol.

P	q	$\sim q$	$p \leftrightarrow \sim q$	$\sim(p \leftrightarrow \sim q)$	$p \leftrightarrow q$
T	T	F	F	T	T
T	F	T	T	F	F
F	T	F	T	F	F
F	F	T	F	T	T

39. If A is an 3×3 non-singular matrix such that $AA' = A'A$ and $B = A^{-1}A'$, then BB' equals
 (1) $I + B$ (2) I
 (3) B^{-1} (4) $(B^{-1})'$

Sol.

2
 $B = A^{-1}A' \Rightarrow AB = A'$
 $ABB' = A'B' = (BA)' = (A^{-1}A'A)' = (A^{-1}AA')' = A.$
 $\Rightarrow BB' = I.$

40. The integral $\int \left(1 + x - \frac{1}{x} \right) e^{x + \frac{1}{x}} dx$ is equal to
 (1) $(x-1)e^{x + \frac{1}{x}} + c$ (2) $x e^{x + \frac{1}{x}} + c$
 (3) $(x+1)e^{x + \frac{1}{x}} + c$ (4) $-x e^{x + \frac{1}{x}} + c$

Sol.

2

$$\begin{aligned}
 &\int \left(1 + x - \frac{1}{x} \right) e^{\left(x + \frac{1}{x} \right)} dx \\
 &= \int e^{\left(x + \frac{1}{x} \right)} dx + \int x \left(1 - \frac{1}{x^2} \right) e^{\left(x + \frac{1}{x} \right)} dx \\
 &= \int e^{\left(x + \frac{1}{x} \right)} dx + x e^{\left(x + \frac{1}{x} \right)} - \int e^{\left(x + \frac{1}{x} \right)} dx \\
 &= x e^{\left(x + \frac{1}{x} \right)} + c
 \end{aligned}$$

41. If z is a complex number such that $|z| \geq 2$, then the minimum value of $\left| z + \frac{1}{2} \right|$
 (1) is equal to $\frac{5}{2}$ (2) lies in the interval (1, 2)
 (3) is strictly greater than $\frac{5}{2}$ (4) is strictly greater than $\frac{3}{2}$ but less than $\frac{5}{2}$

Sol.

2
 $|z| \geq 2$
 $\left| z + \frac{1}{2} \right| \geq \left| |z| - \left| \frac{1}{2} \right| \right| \geq \left| 2 - \frac{1}{2} \right| \geq \frac{3}{2}.$

Hence, minimum distance between z and $\left(-\frac{1}{2}, 0\right)$ is $\frac{3}{2}$

42. If g is the inverse of a function f and $f'(x) = \frac{1}{1+x^5}$, then $g'(x)$ is equal to

- (1) $1+x^5$ (2) $5x^4$
 (3) $\frac{1}{1+\{g(x)\}^5}$ (4) $1+\{g(x)\}^5$

Sol.

4
 $f(g(x)) = x$
 $f'(g(x)) g'(x) = 1$
 $g'(x) = 1 + (g(x))^5$

43. If $\alpha, \beta \neq 0$, and $f(n) = \alpha^n + \beta^n$ and $\begin{vmatrix} 3 & 1+f(1) & 1+f(2) \\ 1+f(1) & 1+f(2) & 1+f(3) \\ 1+f(2) & 1+f(3) & 1+f(4) \end{vmatrix} = K(1-\alpha)^2(1-\beta)^2(\alpha-\beta)^2$, then K is

equal to

- (1) $\alpha\beta$ (2) $\frac{1}{\alpha\beta}$
 (3) 1 (4) -1

Sol.

3

$$\begin{vmatrix} 3 & 1+\alpha+\beta & 1+\alpha^2+\beta^2 \\ 1+\alpha+\beta & 1+\alpha^2+\beta^2 & 1+\alpha^3+\beta^3 \\ 1+\alpha^2+\beta^2 & 1+\alpha^3+\beta^3 & 1+\alpha^4+\beta^4 \end{vmatrix}$$

$$= \begin{vmatrix} 1 & 1 & 1 \\ 1 & \alpha & \beta \\ 1 & \alpha^2 & \beta^2 \end{vmatrix} \begin{vmatrix} 1 & 1 & 1 \\ 1 & \alpha & \alpha^2 \\ 1 & \beta & \beta^2 \end{vmatrix} = \begin{vmatrix} 1 & 0 & 0 \\ 1 & \alpha-1 & \beta-1 \\ 1 & \alpha^2-1 & \beta^2-1 \end{vmatrix}^2$$

$$= ((\alpha-1)(\beta^2-1) - (\beta-1)(\alpha^2-1))^2$$

$$= (\alpha-1)^2(\beta-1)^2(\alpha-\beta)^2 \Rightarrow k = 1$$

44. Let $f_k(x) = \frac{1}{k}(\sin^k x + \cos^k x)$ where $x \in \mathbb{R}$ and $k \geq 1$. Then $f_4(x) - f_6(x)$ equals

- (1) $\frac{1}{6}$ (2) $\frac{1}{3}$
 (3) $\frac{1}{4}$ (4) $\frac{1}{12}$

Sol.

4

$$\frac{1}{4}(\sin^4 x + \cos^4 x) - \frac{1}{6}(\sin^6 x + \cos^6 x)$$

$$= \frac{3(\sin^4 x + \cos^4 x) - 2(\sin^6 x + \cos^6 x)}{12}$$

$$= \frac{3(1 - 2\sin^2 x \cos^2 x) - 2(1 - 3\sin^2 x \cos^2 x)}{12}$$

$$= \frac{1}{12}$$

45. Let α and β be the roots of equation $px^2 + qx + r = 0, p \neq 0$. If p, q, r are in A.P. and $\frac{1}{\alpha} + \frac{1}{\beta} = 4$, then the value of $|\alpha - \beta|$ is

- (1) $\frac{\sqrt{61}}{9}$ (2) $\frac{2\sqrt{17}}{9}$
 (3) $\frac{\sqrt{34}}{9}$ (4) $\frac{2\sqrt{13}}{9}$

Sol.

4
 $\frac{1}{\alpha} + \frac{1}{\beta} = 4$
 $2q = p + r$
 $\Rightarrow -2(\alpha + \beta) = 1 + \alpha\beta$
 $\Rightarrow -2\left(\frac{1}{\alpha} + \frac{1}{\beta}\right) = \frac{1}{\alpha\beta} + 1$
 $\Rightarrow \frac{1}{\alpha\beta} = -9$
 Equation having roots α, β is $9x^2 + 4x - 1 = 0$
 $\alpha, \beta = \frac{-4 \pm \sqrt{16 + 36}}{2 \times 9}$
 $|\alpha - \beta| = \frac{2\sqrt{13}}{9}$.

46. Let A and B be two events such that $P(\overline{A \cup B}) = \frac{1}{6}, P(A \cap B) = \frac{1}{4}$ and $P(\overline{A}) = \frac{1}{4}$, where \overline{A} stands for the complement of the event A. Then the events A and B are

- (1) mutually exclusive and independent (2) equally likely but not independent
 (3) independent but not equally likely (4) independent and equally likely

Sol.

3
 $P(\overline{A \cup B}) = \frac{1}{6}$
 $P(A \cup B) = \frac{5}{6}, P(A) = \frac{3}{4}$
 $P(A \cup B) = P(A) + P(B) - P(A \cap B) = \frac{5}{6}$
 $P(B) = \frac{5}{6} - \frac{3}{4} + \frac{1}{4} = \frac{1}{3}$
 $P(A \cap B) = P(A) \cdot P(B)$
 $\frac{1}{4} = \frac{3}{4} \times \frac{1}{3}$.

47. If f and g are differentiable functions in $[0, 1]$ satisfying $f(0) = 2 = g(1), g(0) = 0$ and $f(1) = 6$, then for some $c \in]0, 1[$

- (1) $2f'(c) = g'(c)$ (2) $2f'(c) = 3g'(c)$
 (3) $f'(c) = g'(c)$ (4) $f'(c) = 2g'(c)$

Sol.

4
 Let $h(x) = f(x) - 2g(x)$
 as $h(0) = h(1) = 2$
 Hence, using Rolle's theorem
 $h'(c) = 0$
 $\Rightarrow f'(c) = 2g'(c)$

48. Let the population of rabbits surviving at a time t be governed by the differential equation $\frac{dp(t)}{dt} = \frac{1}{2}p(t) - 200$. If $p(0) = 100$, then $p(t)$ equals

- (1) $400 - 300 e^{t/2}$ (2) $300 - 200 e^{-t/2}$
 (3) $600 - 500 e^{t/2}$ (4) $400 - 300 e^{-t/2}$

Sol.

1
 $\frac{dp}{dt} = \frac{p-400}{2}$

$\frac{dp}{p-400} = \frac{1}{2} dt$

$\ln |p-400| = \frac{1}{2} t + c$

at $t = 0, p = 100$

$\ln 300 = c$

$\ln \left| \frac{p-400}{300} \right| = \frac{t}{2}$

$\Rightarrow |p-400| = 300 e^{t/2}$

$\Rightarrow 400 - p = 300 e^{t/2}$ (as $p < 400$)

$\Rightarrow p = 400 - 300 e^{t/2}$

49. Let C be the circle with centre at $(1, 1)$ and radius = 1. If T is the circle centred at $(0, y)$, passing through origin and touching the circle C externally, then the radius of T is equal to

- (1) $\frac{\sqrt{3}}{\sqrt{2}}$ (2) $\frac{\sqrt{3}}{2}$
 (3) $\frac{1}{2}$ (4) $\frac{1}{4}$

Sol.

4

According to the figure

$(1+y)^2 = (1-y)^2 + 1 \quad (y > 0)$

$\Rightarrow y = \frac{1}{4}$

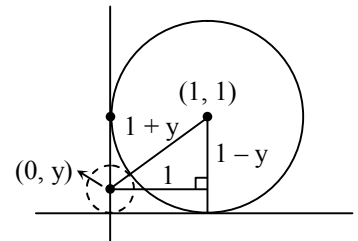

50. The area of the region described by $A = \{(x, y) : x^2 + y^2 \leq 1 \text{ and } y^2 \leq 1 - x\}$ is

- (1) $\frac{\pi}{2} + \frac{4}{3}$ (2) $\frac{\pi}{2} - \frac{4}{3}$
 (3) $\frac{\pi}{2} - \frac{2}{3}$ (4) $\frac{\pi}{2} + \frac{2}{3}$

Sol.

1

$A = \frac{1}{2} \times \pi + 2 \int_0^1 \sqrt{1-x} dx$

$= \frac{\pi}{2} + \frac{4}{3}$

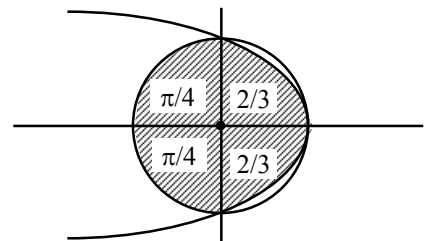

51. Let a, b, c and d be non-zero numbers. If the point of intersection of the lines $4ax + 2ay + c = 0$ and $5bx + 2by + d = 0$ lies in the fourth quadrant and is equidistant from the two axes then

- (1) $2bc - 3ad = 0$ (2) $2bc + 3ad = 0$
 (3) $3bc - 2ad = 0$ (4) $3bc + 2ad = 0$

Sol.

3

Let point of intersection is $(h, -h)$

$$\Rightarrow \begin{cases} 4ah - 2ah + c = 0 \\ 5bh - 2bh + d = 0 \end{cases}$$

$$\text{So, } -\frac{c}{2a} = -\frac{d}{3b}$$

$$3bc - 2ad = 0$$

52. Let PS be the median of the triangle with vertices P(2, 2), Q(6, -1) and R(7, 3). The equation of the line passing through (1, -1) and parallel to PS is

(1) $4x - 7y - 11 = 0$

(2) $2x + 9y + 7 = 0$

(3) $4x + 7y + 3 = 0$

(4) $2x - 9y - 11 = 0$

Sol.

2
S $\left(\frac{13}{2}, 1\right)$, P(2, 2)

Slope = $-\frac{2}{9}$

Equation will be $\frac{y+1}{x-1} = -\frac{2}{9}$

$9y + 9 + 2x - 2 = 0$

$2x + 9y + 7 = 0$

53. $\lim_{x \rightarrow 0} \frac{\sin(\pi \cos^2 x)}{x^2}$ is equal to

(1) $\frac{\pi}{2}$

(2) 1

(3) $-\pi$

(4) π

Sol.

4
 $\lim_{x \rightarrow 0} \frac{\sin(\pi \cos^2 x)}{x^2}$

$= \lim_{x \rightarrow 0} \frac{\sin(\pi - \pi \sin^2 x)}{x^2}$

$= \lim_{x \rightarrow 0} \frac{\sin(\pi \sin^2 x)}{\pi \sin^2 x} \times \frac{\pi \sin^2 x}{x^2} = \pi.$

54. If $X = \{4^n - 3n - 1 : n \in \mathbb{N}\}$ and $Y = \{9(n - 1) : n \in \mathbb{N}\}$, where \mathbb{N} is the set of natural numbers, then $X \cup Y$ is equal to

(1) \mathbb{N}

(2) $Y - X$

(3) X

(4) Y

Sol.

4
Set X contains elements of the form

$4^n - 3n - 1 = (1 + 3)^n - 3n - 1$

$= 3^n + {}^n C_{n-1} 3^{n-1} + \dots + {}^n C_2 3^2$

$= 9(3^{n-2} + {}^n C_{n-1} 3^{n-1} + \dots + {}^n C_2)$

Set X has natural numbers which are multiples of 9 (not all)

Set Y has all multiples of 9

$X \cup Y = Y$

55. The locus of the foot of perpendicular drawn from the centre of the ellipse $x^2 + 3y^2 = 6$ on any tangent to it is

(1) $(x^2 - y^2)^2 = 6x^2 + 2y^2$

(2) $(x^2 - y^2)^2 = 6x^2 - 2y^2$

(3) $(x^2 + y^2)^2 = 6x^2 + 2y^2$

(4) $(x^2 + y^2)^2 = 6x^2 - 2y^2$

Sol.

3
Let the foot of perpendicular be P(h, k)

Equation of tangent with slope m passing P(h, k) is

$$y = mx \pm \sqrt{6m^2 + 2}, \text{ where } m = -\frac{h}{k}$$

$$\Rightarrow \sqrt{\frac{6h^2}{k^2} + 2} = \frac{h^2 + k^2}{k}$$

$$6h^2 + 2k^2 = (h^2 + k^2)^2$$

$$\text{So required locus is } 6x^2 + 2y^2 = (x^2 + y^2)^2.$$

56. Three positive numbers from an increasing G.P. If the middle term in this G.P. is doubled, the new numbers are in A.P. Then the common ratio of the G.P. is

(1) $\sqrt{2} + \sqrt{3}$ (2) $3 + \sqrt{2}$

(3) $2 - \sqrt{3}$ (4) $2 + \sqrt{3}$

Sol.

4

Let numbers be a, ar, ar^2

$$\text{Now, } 2(2ar) = a + ar^2 \quad [a \neq 0]$$

$$\Rightarrow 4r = 1 + r^2$$

$$\Rightarrow r^2 - 4r + 1 = 0$$

$$\Rightarrow r = 2 \pm \sqrt{3}$$

$$r = 2 + \sqrt{3} \quad (\text{Positive value})$$

57. If $(10)^9 + 2(11)^1(10)^8 + 3(11)^2(10)^7 + \dots + 10(11)^9 = k(10)^9$, then k is equal to

(1) $\frac{121}{10}$ (2) $\frac{441}{100}$

(3) 100 (4) 110

Sol.

3

$$S = 10^9 + 2 \cdot 11^1 \cdot 10^8 + \dots + 10 \cdot 11^9$$

$$\frac{11}{10} \cdot S = 11^1 \cdot 10^8 + \dots + 9 \cdot 11^9 + 11^{10}$$

$$\Rightarrow -\frac{1}{10}S = 10^9 + 11^1 \cdot 10^8 + 11^2 \cdot 10^7 + \dots + 11^9 - 11^{10}$$

$$\Rightarrow -\frac{1}{10}S = 10^9 \left(\frac{\left(\frac{11}{10}\right)^{10} - 1}{\frac{11}{10} - 1} \right) - 11^{10} \Rightarrow -\frac{1}{10}S = 11^{10} - 10^{10} - 11^{10}$$

$$S = 10^{11}$$

$$S = 100 \cdot 10^9$$

$$\Rightarrow k = 100.$$

58. The angle between the lines whose direction cosines satisfy the equations $l + m + n = 0$ and $l^2 = m^2 + n^2$ is

(1) $\frac{\pi}{3}$ (2) $\frac{\pi}{4}$

(3) $\frac{\pi}{6}$ (4) $\frac{\pi}{2}$

Sol.

1

$$l = -m - n$$

$$m^2 + n^2 = (m + n)^2$$

$$\Rightarrow mn = 0$$

$$\text{So possibilities are } \left(-\frac{1}{\sqrt{2}}, \frac{1}{\sqrt{2}}, 0\right) \text{ or } \left(-\frac{1}{\sqrt{2}}, 0, \frac{1}{\sqrt{2}}\right)$$

$$\Rightarrow \cos \theta = \frac{1}{2}$$

$$\Rightarrow \theta = \frac{\pi}{3}.$$

59. The slope of the line touching both the parabolas $y^2 = 4x$ and $x^2 = -32y$ is

- (1) $\frac{1}{2}$ (2) $\frac{3}{2}$
 (3) $\frac{1}{8}$ (4) $\frac{2}{3}$

Sol.

1
 Equation of tangent at A $(t^2, 2t)$
 $yt = x + t^2$ is tangent to $x^2 + 32y = 0$ at B

$$\Rightarrow x^2 + 32 \left(\frac{x}{t} + t \right) = 0$$

$$\Rightarrow x^2 + \frac{32}{t}x + 32t = 0$$

$$\Rightarrow \left(\frac{32}{t} \right)^2 - 4(32t) = 0$$

$$\Rightarrow 32 \left(\frac{32}{t^2} - 4t \right) = 0$$

$$\Rightarrow t^3 = 8 \Rightarrow t = 2.$$

$$\Rightarrow \text{Slope of tangent is } \frac{1}{t} = \frac{1}{2}.$$

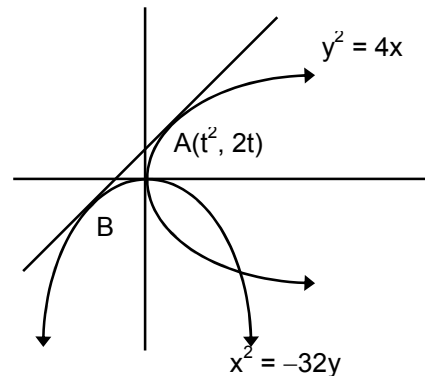

60. If $x = -1$ and $x = 2$ are extreme points of $f(x) = \alpha \log |x| + \beta x^2 + x$, then

- (1) $\alpha = -6, \beta = \frac{1}{2}$ (2) $\alpha = -6, \beta = -\frac{1}{2}$
 (3) $\alpha = 2, \beta = -\frac{1}{2}$ (4) $\alpha = 2, \beta = \frac{1}{2}$

Sol.

3

$$f'(x) = \frac{\alpha}{x} + 2\beta x + 1$$

$$2\beta x^2 + x + \alpha = 0 \text{ has roots } -1 \text{ and } 2$$

PART - C: CHEMISTRY

61. Which one of the following properties is **not** shown by NO?

- (1) It combines with oxygen to form nitrogen dioxide
- (2) It's bond order is 2.5
- (3) It is diamagnetic in gaseous state
- (4) It is a neutral oxide

Sol. 3

NO is paramagnetic in gaseous state due to the presence of unpaired electron in its structure.

62. If Z is a compressibility factor, van der Waals equation at low pressure can be written as:

- | | |
|-----------------------------|-----------------------------|
| (1) $Z = 1 - \frac{Pb}{RT}$ | (2) $Z = 1 + \frac{Pb}{RT}$ |
| (3) $Z = 1 + \frac{RT}{Pb}$ | (4) $Z = 1 - \frac{a}{VRT}$ |

Sol. 4

$$\left(P + \frac{n^2a}{V^2}\right)(V - nb) = nRT$$

For 1 mole, $\left(P + \frac{a}{V^2}\right)(V - b) = RT$

$$PV = RT + Pb - \frac{a}{V} + \frac{ab}{V^2}$$

at low pressure, terms Pb & $\frac{ab}{V^2}$ will be negligible as compared to RT .

So, $PV = RT - \frac{a}{V}$

$$Z = 1 - \frac{a}{RTV}$$

63. The metal that cannot be obtained by electrolysis of an aqueous solution of its salts is:

- | | |
|--------|--------|
| (1) Cu | (2) Cr |
| (3) Ag | (4) Ca |

Sol. 4

During the electrolysis of aqueous solution of s-block elements, H_2 gas is obtained at cathode.

64. Resistance of 0.2 M solution of an electrolyte is 50Ω . The specific conductance of the solution is $1.4 S m^{-1}$. The resistance of 0.5 M solution of the same electrolyte is 280Ω . The molar conductivity of 0.5 M solution of the electrolyte in $S m^2 mol^{-1}$ is:

- | | |
|------------------------|------------------------|
| (1) 5×10^3 | (2) 5×10^2 |
| (3) 5×10^{-4} | (4) 5×10^{-3} |

Sol. 3

$$50 = \frac{1}{K} \times \frac{\ell}{A}$$

$$50 = \frac{1}{1.4} \times \frac{\ell}{A}$$

$$\frac{\ell}{A} = 70 m^{-1}$$

$$280 = \frac{1}{K} \times 70$$

$$K = \frac{1}{4} S m^{-1}$$

$$\Lambda_m = \frac{1}{4} \times \left(\frac{1000}{M}\right) (10^{-2} m)^3$$

$$= \frac{1}{4} \times \frac{1000}{0.5} \times 10^{-6}$$

$$= 500 \times 10^{-6} = 5 \times 10^{-4} \text{ Sm}^2 \text{ mol}^{-1}$$

65. CsCl crystallises in body centred cubic lattice. If 'a' is its edge length then which of the following expressions is correct?

- (1) $r_{\text{Cs}^+} + r_{\text{Cl}^-} = \frac{\sqrt{3}}{2} a$ (2) $r_{\text{Cs}^+} + r_{\text{Cl}^-} = \sqrt{3} a$
- (3) $r_{\text{Cs}^+} + r_{\text{Cl}^-} = 3a$ (4) $r_{\text{Cs}^+} + r_{\text{Cl}^-} = \frac{3a}{2}$

Sol. 1

In CsCl structure, Cs^+ ion is in contact with Cl^- ion at the nearest distance which is equal to $\sqrt{3} \frac{a}{2}$

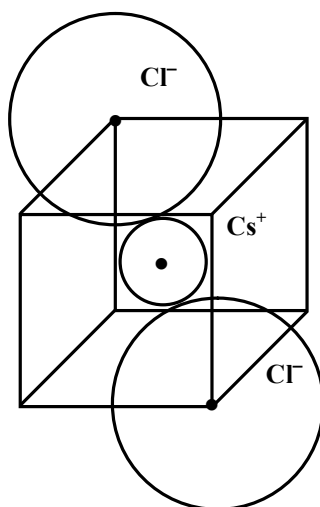

66. Consider separate solutions of 0.500 M $\text{C}_2\text{H}_5\text{OH}(\text{aq})$, 0.100 M $\text{Mg}_3(\text{PO}_4)_2(\text{aq})$, 0.250 M $\text{KBr}(\text{aq})$ and 0.125 M $\text{Na}_3\text{PO}_4(\text{aq})$ at 25°C . Which statement is **true** about these solutions, assuming all salts to be strong electrolytes?

- (1) 0.125 M $\text{Na}_3\text{PO}_4(\text{aq})$ has the highest osmotic pressure.
 (2) 0.500 M $\text{C}_2\text{H}_5\text{OH}(\text{aq})$ has the highest osmotic pressure.
 (3) They all have the same osmotic pressure.
 (4) 0.100 M $\text{Mg}_3(\text{PO}_4)_2(\text{aq})$ has the highest osmotic pressure.

Sol. 3

For $\text{C}_2\text{H}_5\text{OH}$, $\pi = 1 \times 0.5 \times RT$
 For KBr , $\pi = 2 \times 0.25 \times RT$
 For $\text{Mg}_3(\text{PO}_4)_2$, $\pi = 5 \times 0.1 \times RT$
 For Na_3PO_4 , $\pi = 4 \times 0.125 \times RT$
 So, all are isotonic solutions.

67. In which of the following reactions H_2O_2 acts as a reducing agent?

- (a) $\text{H}_2\text{O}_2 + 2\text{H}^+ + 2\text{e}^- \longrightarrow 2\text{H}_2\text{O}$
 (b) $\text{H}_2\text{O}_2 - 2\text{e}^- \longrightarrow \text{O}_2 + 2\text{H}^+$
 (c) $\text{H}_2\text{O}_2 + 2\text{e}^- \longrightarrow 2\text{OH}^-$
 (d) $\text{H}_2\text{O}_2 + 2\text{OH}^- - 2\text{e}^- \longrightarrow \text{O}_2 + 2\text{H}_2\text{O}$

- (1) (a), (c) (2) (b), (d)
 (3) (a), (b) (4) (c), (d)

Sol. 2

A reducing agent loses electrons during redox reaction.
 Hence (b, d) is correct.

68. In S_N2 reactions, the correct order of reactivity for the following compounds: CH_3Cl , CH_3CH_2Cl , $(CH_3)_2CHCl$ and $(CH_3)_3CCl$ is:
- (1) $CH_3CH_2Cl > CH_3Cl > (CH_3)_2CHCl > (CH_3)_3CCl$
 (2) $(CH_3)_2CHCl > CH_3CH_2Cl > CH_3Cl > (CH_3)_3CCl$
 (3) $CH_3Cl > (CH_3)_2CHCl > CH_3CH_2Cl > (CH_3)_3CCl$
 (4) $CH_3Cl > CH_3CH_2Cl > (CH_3)_2CHCl > (CH_3)_3CCl$

Sol. 4

$$\text{Rate of } S_N2 \text{ reaction} \propto \frac{1}{\text{steric over crowding in transition state}}$$

69. The octahedral complex of a metal ion M^{3+} with four monodentate ligands L_1 , L_2 , L_3 and L_4 absorb wavelengths in the region of red, green, yellow and blue, respectively. The increasing order of ligand strength of the four ligands is:
- (1) $L_3 < L_2 < L_4 < L_1$ (2) $L_1 < L_2 < L_4 < L_3$
 (3) $L_4 < L_3 < L_2 < L_1$ (4) $L_1 < L_3 < L_2 < L_4$

Sol. 4

Strong field ligands cause higher magnitude of crystal field splitting which is accompanied by the absorption of higher energy radiation.

V I B G Y O R → decreasing energy

70. For the estimation of nitrogen, 1.4 g of organic compound was digested by Kjeldahl method and the evolved ammonia was absorbed in 60 mL of $\frac{M}{10}$ sulphuric acid. The unreacted acid required 20 ml of $\frac{M}{10}$ sodium hydroxide for complete neutralization. The percentage of nitrogen in the compound is:
- (1) 3% (2) 5%
 (3) 6% (4) 10%

Sol. 4

$$\% \text{ of N} = \frac{1.4 \times \text{milliequivalents of acid consumed}}{\text{mass of organic compound}}$$

$$\text{Meq of acid consumed} = \left(60 \times \frac{1}{10} \times 2\right) - \left(20 \times \frac{1}{10} \times 1\right)$$

$$= 10$$

$$\therefore \% \text{ of N} = \frac{1.4 \times 10}{1.4} = 10\%$$

71. The equivalent conductance of $NaCl$ at concentration C and at infinite dilution are λ_C and λ_∞ , respectively. The correct relationship between λ_C and λ_∞ is given as: (where the constant B is positive)

- (1) $\lambda_C = \lambda_\infty - (B) \sqrt{C}$ (2) $\lambda_C = \lambda_\infty + (B) \sqrt{C}$
 (3) $\lambda_C = \lambda_\infty + (B)C$ (4) $\lambda_C = \lambda_\infty - (B)C$

Sol. 1

According to Debye Huckel's Theory for a strong electrolyte,

$$\lambda_C = \lambda_\infty - B\sqrt{C}$$

72. For the reaction, $SO_{2(g)} + \frac{1}{2}O_{2(g)} \rightleftharpoons SO_{3(g)}$, if $K_p = K_c(RT)^x$ where the symbols have usual meaning then the value of x is: (assuming ideality)

- (1) $\frac{1}{2}$ (2) 1
 (3) -1 (4) $-\frac{1}{2}$

Sol. 4

For reaction:

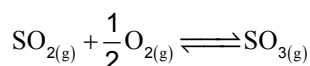

$$\Delta n_g = -\frac{1}{2} = x$$

73. In the reaction,
 $\text{CH}_3\text{COOH} \xrightarrow{\text{LiAlH}_4} \text{A} \xrightarrow{\text{PCl}_5} \text{B} \xrightarrow{\text{alc. KOH}} \text{C}$,
 the product C is:

- (1) Ethylene (2) Acetyl chloride
 (3) Acetaldehyde (4) Acetylene

Sol. 1

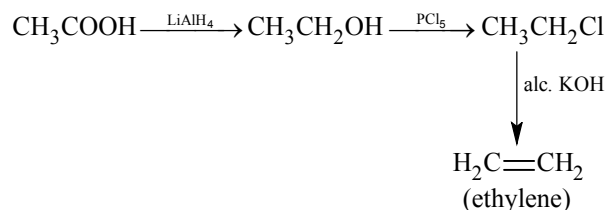

74. Sodium phenoxide when heated with CO_2 under pressure at 125°C yields a product which on acetylation produces C.

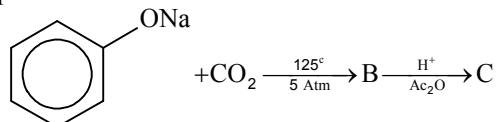

The major product C would be:

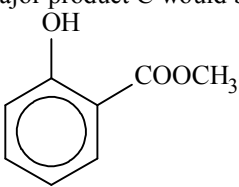
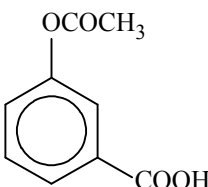
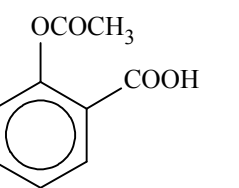
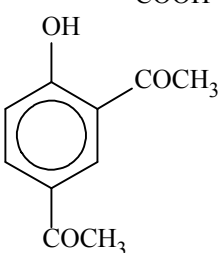
- (1) 
- (2) 
- (3) 
- (4) 

Sol. 3

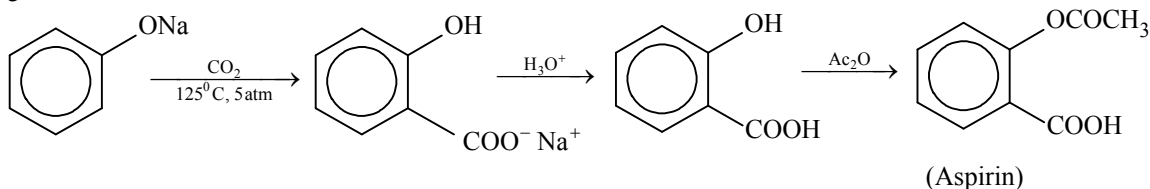

75. On heating an aliphatic primary amine with chloroform and ethanolic potassium hydroxide, the organic compound formed is:

- (1) an alkyl cyanide (2) an alkyl isocyanide
 (3) an alkanol (4) an alkanediol

Sol. 2

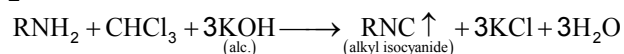

76. The correct statement for the molecule, CsI_3 is:
 (1) it contains Cs^{3+} and I^- ions. (2) it contains Cs^+ , I^- and lattice I_2 molecule.
 (3) it is a covalent molecule. (4) it contains Cs^+ and I_3^- ions.

Sol. 4

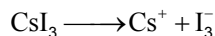

\Rightarrow Cs cannot show +3 oxidation state.

\Rightarrow I_2 molecules are too large to be accommodated in lattice.

77. The equation which is balanced and represents the correct product(s) is:

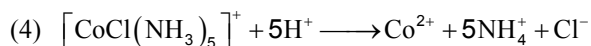
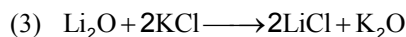
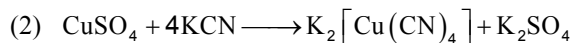
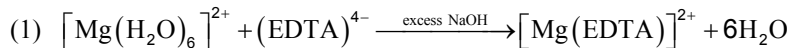

Sol. 4

Equation – 1 is not balanced w.r.t. charge.

Equation – 2 gives $\text{K}_3[\text{Cu}(\text{CN})_4]$ as product.

Equation – 3 reaction is unfavourable in the forward direction (K_2O is unstable, while Li_2O is stable).

Equation – 4 is correct & balanced.

78. For which of the following molecule significant $\mu \neq 0$?

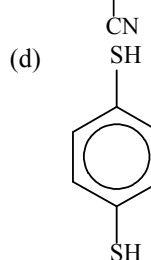
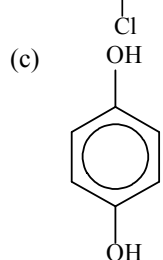
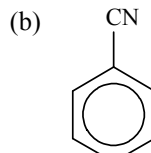
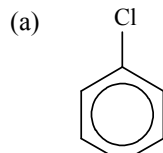

(1) Only (c)

(3) Only (a)

(2) (c) and (d)

(4) (a) and (b)

Sol. 2

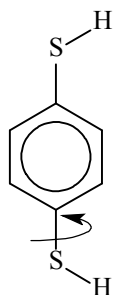
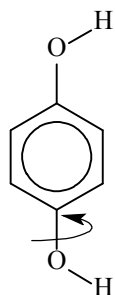

Due to infinite possible conformations in the above cases (of which only one has zero μ); a weighted μ will finally exist.

79. For the non – stoichiometre reaction $2\text{A} + \text{B} \longrightarrow \text{C} + \text{D}$, the following kinetic data were obtained in three separate experiments, all at 298 K.

Initial Concentration (A)	Initial Concentration (B)	Initial rate of formation of C ($\text{mol L}^{-1}\text{S}^{-1}$)
0.1 M	0.1 M	1.2×10^{-3}
0.1 M	0.2 M	1.2×10^{-3}
0.2 M	0.1 M	2.4×10^{-3}

The rate law for the formation of C is:

$$(1) \frac{dc}{dt} = k[A][B]^2$$

$$(2) \frac{dc}{dt} = k[A]$$

$$(3) \frac{dc}{dt} = k[A][B]$$

$$(4) \frac{dc}{dt} = k[A]^2[B]$$

Sol. 2

$$R = k[A]^x[B]^y$$

$$1.2 \times 10^{-3} = k[0.1]^x[0.1]^y$$

$$1.2 \times 10^{-3} = k[0.1]^x[0.2]^y$$

$$2.4 \times 10^{-3} = k[0.2]^x[0.1]^y$$

Solving $x = 1, y = 0$

$$R = k[A]$$

80. Which series of reactions correctly represents chemical reactions related to iron and its compound?

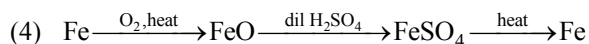
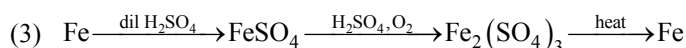
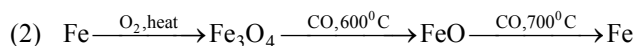
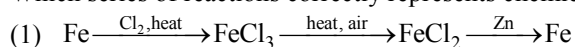

Sol. 2

In Eq. (1) FeCl_3 cannot be reduced when heated in air.

In Eq. (3) $\text{Fe}_2(\text{SO}_4)_3$ cannot convert to Fe on heating; instead oxide(s) will be formed.

In Eq. (4) FeSO_4 cannot be converted to Fe on heating; instead oxide(s) will be formed.

Hence Eq. (2) is correct.

81. Considering the basic strength of amines in aqueous solution, which one has the smallest pK_b value?

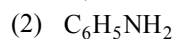
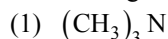

Sol. 3

Aliphatic amines are more basic than aromatic amines.

$(\text{CH}_3)_2\text{NH} > \text{CH}_3\text{NH}_2 > (\text{CH}_3)_3\text{N}$ (among aliphatic amines in water).

82. Which one of the following bases is **not** present in DNA?

(1) Cytosine

(2) Thymine

(3) Quinoline

(4) Adenine

Sol. 3

Adenine, Thymine, Cytosine, Guanine are bases present in DNA.

Quinoline an aromatic compound is NOT present in DNA.

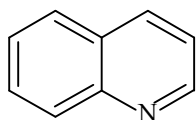

(Quinoline)

83. The correct set of four quantum numbers for the valence electrons of rubidium atom ($Z = 37$) is:

$$(1) 5, 1, 1, +\frac{1}{2}$$

$$(2) 5, 0, 1, +\frac{1}{2}$$

$$(3) 5, 0, 0, +\frac{1}{2}$$

$$(4) 5, 1, 0, +\frac{1}{2}$$

Sol. 3

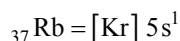

$$n = 5, l = 0, m = 0, s = +\frac{1}{2}$$

84. The major organic compound formed by the reaction of 1, 1, 1-trichloroethane with silver powder is:

- (1) 2-Butyne (2) 2-Butene
(3) Acetylene (4) Ethene

Sol. 1

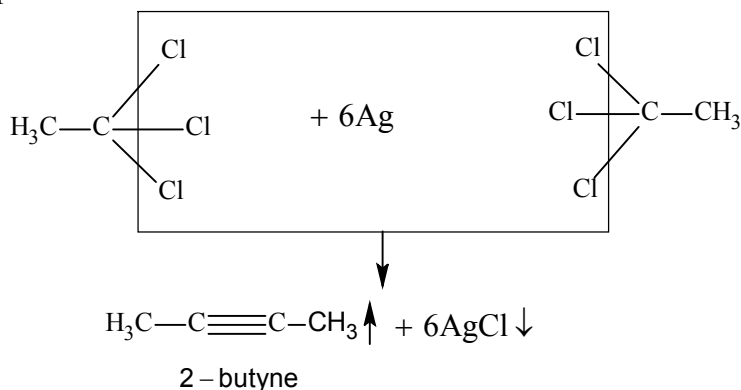

85. Given below are the half-cell reactions:

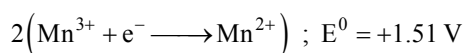
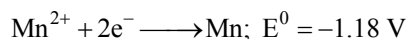

The E^0 for $3\text{Mn}^{2+} \longrightarrow \text{Mn} + 2\text{Mn}^{3+}$ will be:

- (1) -0.33 V ; the reaction will not occur (2) -0.33 V ; the reaction will occur
(3) -2.69 V ; the reaction will not occur (4) -2.69 V ; the reaction will occur

Sol. 3

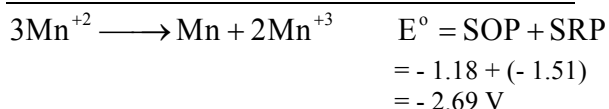
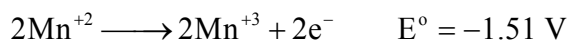

Negative EMF reflects non-spontaneous cell reaction.

86. The ratio of masses of oxygen and nitrogen in a particular gaseous mixture is 1 : 4. The ratio of number of their molecule is:

- (1) 1 : 8 (2) 3 : 16
(3) 1 : 4 (4) 7 : 32

Sol. 4

$$\text{Moles of O}_2 = \frac{w}{32}$$

$$\text{Moles of N}_2 = \frac{4w}{28}$$

$$\frac{n_{\text{O}_2}}{n_{\text{N}_2}} = \frac{w}{32} \times \frac{28}{4w} = \frac{7}{32}$$

87. Which one is classified as a condensation polymer?

- (1) Teflon (2) Acrylonitrile
(3) Dacron (4) Neoprene

Sol. 3
Teflon, Acrylonitrile and Neoprene are addition polymers while Dacron is a condensation polymer.

88. Among the following oxoacids, the correct decreasing order of acid strength is:
 (1) $\text{HClO}_4 > \text{HClO}_3 > \text{HClO}_2 > \text{HOCl}$ (2) $\text{HClO}_2 > \text{HClO}_4 > \text{HClO}_3 > \text{HOCl}$
 (3) $\text{HOCl} > \text{HClO}_2 > \text{HClO}_3 > \text{HClO}_4$ (4) $\text{HClO}_4 > \text{HOCl} > \text{HClO}_2 > \text{HClO}_3$

Sol. 1
 $\text{HClO} < \text{HClO}_2 < \text{HClO}_3 < \text{HClO}_4$
 Increasing acid strength due to increase in oxidation state of central atom.

89. For complete combustion of ethanol, $\text{C}_2\text{H}_5\text{OH}(\ell) + 3\text{O}_2(\text{g}) \longrightarrow 2\text{CO}_2(\text{g}) + 3\text{H}_2\text{O}(\ell)$, the amount of heat produced as measured in bomb calorimeter, is $1364.47 \text{ kJ mol}^{-1}$ at 25°C . Assuming ideality the Enthalpy of combustion, $\Delta_c H$, for the reaction will be: ($R = 8.314 \text{ kJ mol}^{-1}$)
 (1) $-1460.50 \text{ kJ mol}^{-1}$ (2) $-1350.50 \text{ kJ mol}^{-1}$
 (3) $-1366.95 \text{ kJ mol}^{-1}$ (4) $-1361.95 \text{ kJ mol}^{-1}$

Sol. 3
 $\text{C}_2\text{H}_5\text{OH}(\ell) + 3\text{O}_2(\text{g}) \longrightarrow 2\text{CO}_2(\text{g}) + 3\text{H}_2\text{O}(\ell)$
 $\Delta E = -1364.47 \text{ kJ / mole}$
 $\Delta H = ?$
 $T = 298 \text{ K}$
 $\Delta n_g = -1$
 $\therefore \Delta H = \Delta E + \Delta n_g RT$
 So, $\Delta H = -1366.95 \text{ kJ / mole}$

90. The most suitable reagent for the conversion of $\text{R}-\text{CH}_2-\text{OH} \longrightarrow \text{R}-\text{CHO}$ is:
 (1) CrO_3 (2) PCC (Pyridinium Chlorochromate)
 (3) KMnO_4 (4) $\text{K}_2\text{Cr}_2\text{O}_7$

Sol. 2
 $\text{RCH}_2\text{OH} \xrightarrow{\text{PCC}} \text{RCHO}$